

# TOSHIBA

**INSTALLATION'S MANUAL**  
MANUEL D'INSTALLATION  
EINBAUANLEITUNG  
MANUALE DI INSTALLAZIONE  
MANUAL DE INSTALACIÓN  
ΟΔΗΓΙΕΣ ΕΓΚΑΤΑΣΤΑΣΗΣ  
MANUAL DE INSTALAÇÃO  
BUKU PANDUAN PEMASANGAN  
BUKU PETUNJUK PEMASANGAN  
คู่มือการติดตั้ง  
安裝手冊

## AIR CONDITIONER (SPLIT TYPE)

CLIMATISEUR (TYPE SEPARÉ)  
KLIMAGERÄT (GETEILTE AUSFÜHRUNG)  
CONDIZIONATORE D'ARIA (TIPO SPLIT)  
ACONDICIONADOR DE AIRE (TIPO SEPARADO)  
ΚΛΙΜΑΤΙΣΤΙΚΟ (ΔΙΑΙΡΟΥΜΕΝΟΥ ΤΥΠΟΥ)  
SISTEMA DE AR CONDICIONADO (TIPO SPLIT)  
ALAT PENYAMAN UDARA (JENIS BERASINGAN)  
PENYEJUK UDARA (JENIS TERPISAH)

เครื่องปรับอากาศ (แบบแยกส่วน)  
空調器 (分體式)

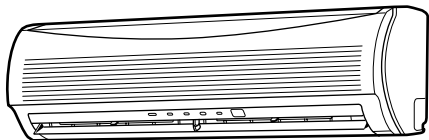

Indoor Unit  
Unité intérieure  
Innenraumgerät  
Unità interna  
Unidad interior  
Εσωτερική μονάδα  
Unit Dalam Rumah  
Unit Dalam

ตัวเครื่องภายใน  
室內機組

**RAS-10JKVP-E / RAS-10JAVP-E**  
**RAS-13JKVP-E / RAS-13JAVP-E**  
**RAS-10JKCVP/RAS-10JACVP**  
**RAS-13JKCVP/RAS-13JACVP**

Pour utilisation grand public  
Für allgemeine Verwendung  
Per l'uso in generale  
Para el uso público general  
Για γενική δημόσια χρήση  
Para utilização geral  
Untuk kegunaan umum  
Untuk kegunaan umum

สำหรับการใช้งานทั่วไป  
供一般公眾使用

Outdoor Unit  
Unité extérieure  
Außengerät  
Unità esterna  
Unidad exterior  
Εξωτερική μονάδα  
Unit Luar Rumah  
Unit Luar

ตัวเครื่องภายนอก  
室外機組

Please read this installation manual carefully before installing the air conditioner.

Veillez lire attentivement ce manuel avant d'installer le climatiseur.

Lesen Sie diese Einbauanleitung sorgfältig durch, bevor Sie das Klimagerät installieren.

Prima di installare il condizionatore d'aria, si consiglia di leggere con attenzione il presente manuale di installazione.

Lea este manual de instalación atentamente antes de instalar el acondicionador de aire.

Παρακαλούμε διαβάστε αυτές τις οδηγίες εγκατάστασης προσεκτικά πριν εγκαταστήσετε το κλιματιστικό.

Leia atentamente este manual de instalação antes de instalar o sistema de ar condicionado.

Sila baca buku panduan pemasangan ini dengan teliti sebelum memasang penyaman udara.

Bacalah buku petunjuk pemasangan ini dengan teliti sebelum memasang penyejuk udara.

กรุณาอ่านคู่มือการติดตั้งอย่างละเอียดก่อนทำการติดตั้งเครื่องปรับอากาศ

安裝空調器之前，請仔細閱讀本安裝手冊。

ENGLISH

FRANÇAIS

DEUTSCH

ITALIANO

ESPAÑOL

ΕΛΛΗΝΙΚΗ

PORTUGUÊS

BAHASA MELAYU

BAHASA INDONESIA

ภาษาไทย

中文

# CONTENTS/SOMMAIRE/INHALT/INDICE/ÍNDICE/ΠΕΡΙΕΧΟΜΕΝΑ/ ÍNDICE/KANDUNGAN/DAFTAR ISI/สารบัญ/目錄

## ENGLISH

1 SAFETY PRECAUTIONS .....	1
2 INSTALLATION DIAGRAM OF INDOOR AND OUTDOOR UNITS .....	3
3 OPTIONAL PARTS, ACCESORIES AND TOOLS .....	4
4 INSTALLATION OF INDOOR UNIT .....	6
5 INSTALLATION OF OUTDOOR UNIT .....	12
6 TEST OPERATION .....	16

## FRANÇAIS

1 MESURES DE SECURITE .....	1
2 SCHEMAS D'INSTALLATION DES UNITES INTERIEURE ET EXTERIEURE .....	3
3 PIECES EN OPTION, ACCESSOIRES ET OUTILS .....	4
4 INSTALLATION DE L'UNITE INTERIEURE .....	6
5 INSTALLATION DE L'UNITE EXTERIEURE .....	12
6 OPERATION D'ESSAI .....	16

## DEUTSCH

1 SICHERHEITSVORKEHRUNGEN .....	1
2 EINBAUZEICHNUNGEN FÜR INNENRAUM- UND AUSSENGERÄT .....	3
3 SONDERTEILE, SONDERZUBEHÖR UND WERKZEUGE .....	4
4 INSTALLATION DES INNENRAUMGERÄTS .....	6
5 INSTALLATION DES AUSSENGERÄTS .....	12
6 PROBELAUF .....	16

## ITALIANO

1 PRECAUZIONI PER LA SICUREZZA .....	1
2 SCHEMA DI INSTALLAZIONE DELL'UNITÀ INTERNA E DELL'UNITÀ ESTERNA .....	3
3 COMPONENTI OPZIONALI, ACCESSORI E STRUMENTI .....	4
4 INSTALLAZIONE DELL'UNITÀ INTERNA .....	6
5 INSTALLAZIONE DELL'UNITÀ ESTERNA .....	12
6 FUNZIONAMENTO DI PROVA .....	16

## ESPAÑOL

1 PRECAUCIONES SOBRE SEGURIDAD .....	1
2 DIAGRAMA DE INSTALACIÓN DE LAS UNIDADES INTERIOR Y EXTERIOR .....	3
3 PARTES OPCIONALES, ACCESORIOS Y HERRAMIENTAS .....	4
4 INSTALACIÓN DE LA UNIDAD INTERIOR .....	6
5 INSTALACIÓN DE LA UNIDAD EXTERIOR .....	12
6 OPERACIÓN DE PRUEBA .....	16

## ΕΛΛΗΝΙΚΗ

1 ΠΡΟΦΥΛΑΞΕΙΣ ΑΣΦΑΛΕΙΑΣ .....	1
2 ΔΙΑΓΡΑΜΜΑ ΕΓΚΑΤΑΣΤΑΣΗΣ ΕΣΩΤΕΡΙΚΗΣ ΚΑΙ ΕΞΩΤΕΡΙΚΗΣ ΜΟΝΑΔΑΣ .....	3
3 ΠΡΟΑΙΡΕΤΙΚΑ ΑΝΤΑΛΛΑΚΤΙΚΑ, ΕΞΑΡΤΗΜΑΤΑ ΚΑΙ ΕΡΓΑΛΕΙΑ .....	4
4 ΕΓΚΑΤΑΣΤΑΣΗ ΕΣΩΤΕΡΙΚΗΣ ΜΟΝΑΔΑΣ .....	6
5 ΕΓΚΑΤΑΣΤΑΣΗ ΕΞΩΤΕΡΙΚΗΣ ΜΟΝΑΔΑΣ .....	12
6 ΔΟΚΙΜΑΣΤΙΚΗ ΛΕΙΤΟΥΡΓΙΑ .....	16

## PORTUGUÊS

1 PRECAUÇÕES DE SEGURANÇA .....	1
2 DIAGRAMA DE INSTALAÇÃO DAS UNIDADES INTERIOR E EXTERIOR .....	3
3 PEÇAS OPCIONAIS, ACESSÓRIOS E FERRAMENTAS .....	4
4 INSTALAÇÃO DA UNIDADE INTERIOR .....	6
5 INSTALAÇÃO DA UNIDADE EXTERIOR .....	12
6 TESTE .....	16

## BAHASA MELAYU

1 LANGKAH KESELAMATAN .....	1
2 RAJAH PEMASANGAN UNIT DALAM DAN LUAR RUMAH .....	3
3 BAHAGIAN-BAHAGIAN, EKSESORI DAN ALAT-ALAT DAN PILIHAN .....	4
4 PEMASANGAN UNIT DALAM RUMAH .....	6
5 PEMASANGAN UNIT LUAR RUMAH .....	12
6 OPERASI UJIAN .....	16

## BAHASA INDONESIA

1 TINDAKAN PENCEGAHAN BAGI KESELAMATAN .....	1
2 DIAGRAM PEMASANGAN UNIT DALAM DAN UNIT LUAR .....	3
3 SUKU CADANG OPSIONAL, AKSESORI DAN PERALATAN .....	4
4 PEMASANGAN UNIT DALAM .....	6
5 PEMASANGAN UNIT LUAR .....	12
6 UJI COBA .....	16

## ภาษาไทย

1 ข้อควรระวังเพื่อความปลอดภัย .....	1
2 แผนภาพการติดตั้งสำหรับตัวเครื่องในและนอกอาคาร .....	3
3 ส่วนประกอบเพิ่มเติม อุปกรณ์เสริม และเครื่องมือต่างๆ .....	4
4 การติดตั้งตัวเครื่องภายในอาคาร .....	6
5 การติดตั้งตัวเครื่องภายนอกอาคาร .....	12
6 ทดสอบการทำงาน .....	16

## 中文

1 安全預防措施 .....	1
2 室內和室外機組安裝圖解 .....	3
3 選購的零件、配件和工具 .....	4
4 安裝室內機組 .....	6
5 安裝室外機組 .....	12
6 測試操作 .....	16

ENGLISH

FRANÇAIS

DEUTSCH

ITALIANO

ESPAÑOL

ΕΛΛΗΝΙΚΗ

PORTUGUÊS

BAHASA MELAYU

BAHASA INDONESIA

ภาษาไทย

中文

# 1 SAFETY PRECAUTIONS

## For general public use

Power supply cord of outdoor unit shall be more than 1.5 mm<sup>2</sup> (H07RN-F or 245IEC66) polychloroprene sheathed flexible cord.

### CAUTION

#### New Refrigerant Air Conditioner Installation

• **THIS AIR CONDITIONER ADOPTS THE NEW HFC REFRIGERANT (R410A) WHICH DOES NOT DESTROY OZONE LAYER.** R410A refrigerant is apt to be affected by impurities such as water, oxidizing membrane, and oils because the working pressure of R410A refrigerant is approx. 1.6 times of refrigerant R22. Accompanied with the adoption of the new refrigerant, the refrigeration machine oil has also been changed. Therefore, during installation work, be sure that water, dust, former refrigerant, or refrigeration machine oil does not enter into the new type refrigerant R410A air conditioner circuit. To prevent mixing of refrigerant or refrigerating machine oil, the sizes of connecting sections of charging port on main unit and installation tools are different from those used for the conventional refrigerant units. Accordingly, special tools are required for the new refrigerant (R410A) units as shown on page 5. For connecting pipes, use new and clean piping materials with high pressure fittings made for R410A only, so that water and/or dust does not enter. Moreover, do not use the existing piping because there are some problems with pressure fittings and possible impurities in existing piping.

### CAUTION

#### TO DISCONNECT THE APPLIANCE FROM THE MAIN POWER SUPPLY

This appliance must be connected to the main power supply by a circuit breaker or a switch with a contact separation of at least 3 mm.

The installation fuse (25A D type ) must be used for the power supply line of this air conditioner. (RAS-10JKVP-E and RAS-13JKVP-E)

### DANGER

- FOR USE BY QUALIFIED PERSONS ONLY.
- TURN OFF MAIN POWER SUPPLY BEFORE ATTEMPTING ANY ELECTRICAL WORK. MAKE SURE ALL POWER SWITCHES ARE OFF. FAILURE TO DO SO MAY CAUSE ELECTRIC SHOCK.
- CORRECTLY CONNECT THE CONNECTING CABLE. IF THE CONNECTING CABLE IS INCORRECTLY CONNECTED, ELECTRIC PARTS MAY BE DAMAGED.
- CHECK THAT THE EARTH WIRE IS NOT BROKEN OR DISCONNECTED BEFORE INSTALLATION.
- DO NOT INSTALL NEAR CONCENTRATIONS OF COMBUSTIBLE GAS OR GAS VAPORS. FAILURE TO FOLLOW THIS INSTRUCTION CAN RESULT IN FIRE OR EXPLOSION.
- TO PREVENT THE INDOOR UNIT FROM OVERHEATING AND CAUSING A FIRE HAZARD, PLACE THE UNIT WELL AWAY (MORE THAN 2 M) FROM HEAT SOURCES SUCH AS RADIATORS, HEAT REGISTORS, FURNACE, STOVES, ETC.
- WHEN MOVING THE AIR-CONDITIONER FOR INSTALLATION IN ANOTHER PLACE, BE VERY CAREFUL NOT TO ALLOW THE SPECIFIED REFRIGERANT (R-410A) TO BECOME MIXED WITH ANY OTHER GASEOUS BODY INTO THE REFRIGERATION CIRCUIT. IF AIR OR ANY OTHER GAS IS MIXED IN THE REFRIGERANT, THE GAS PRESSURE IN THE REFRIGERATION CIRCUIT WILL BECOME ABNORMALLY HIGH AND IT MAY RESULT IN THE PIPE BURSTING AND POSSIBLE PERSONNEL INJURIES.
- IN THE EVENT THAT THE REFRIGERANT GAS LEAKS OUT OF THE PIPE DURING THE INSTALLATION WORK, IMMEDIATELY LET FRESH AIR INTO THE ROOM. IF THE REFRIGERANT GAS IS HEATED, SUCH AS BY FIRE, GENERATION OF POISONOUS GAS MAY RESULT.

## **WARNING**

- Never modify this unit by removing any of the safety guards or by-pass any of the safety interlock switches.
- Do not install in a place which cannot bear the weight of the unit. Personal injury and property damage can result if the unit falls.
- Before doing any electrical work, attach an approved plug to the power supply cord and make sure the equipment is grounded.
- Appliance shall be installed in accordance with national wiring regulations.
- If you detect any damage, do not install the unit. Contact your Toshiba dealer immediately.

## **CAUTION**

- Exposure of unit to water or other moisture before installation may result in an electrical short. Do not store in a wet basement or expose to rain or water.
- After unpacking the unit, examine it carefully for any damage.
- Do not install in a place that can increase the vibration of the unit. Do not install in a place that can amplify the noise level of the unit or where noise or discharged air might disturb neighbors.
- To avoid personal injury, be careful when handling parts with sharp edges.
- Please read this installation manual carefully before installing the unit. It contains further important instructions necessary for proper installation.

# 2 INSTALLATION DIAGRAM OF INDOOR AND OUTDOOR UNITS

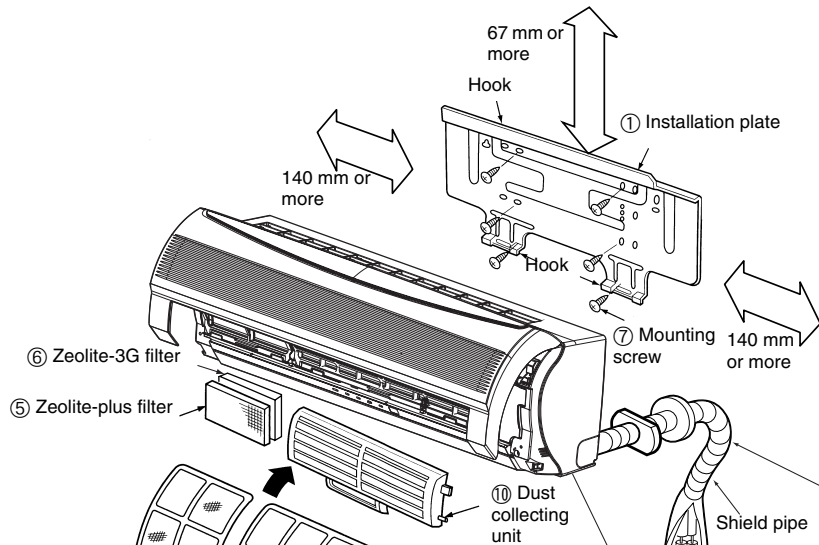

### Before installing the wireless remote control

- With the remote control cover removed, correctly load the supplied batteries while observing their polarity.

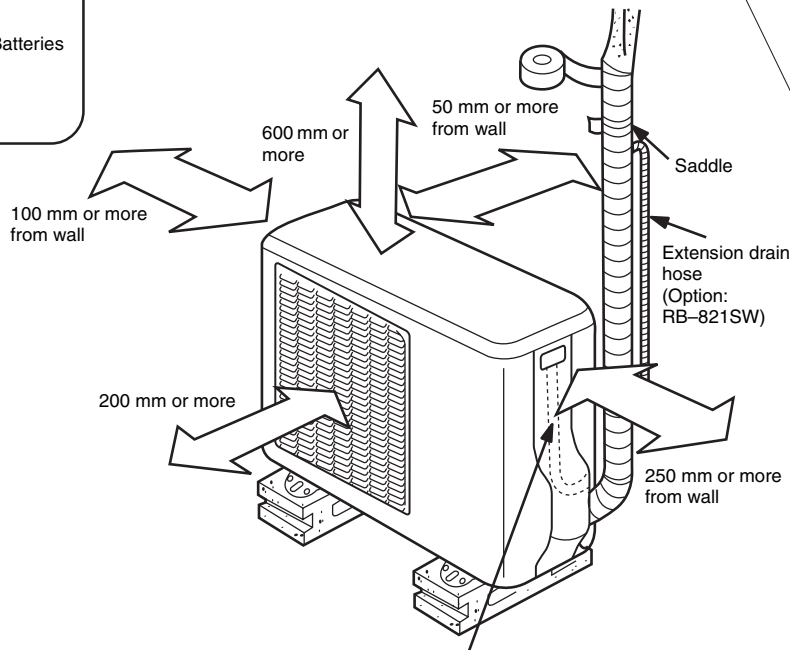
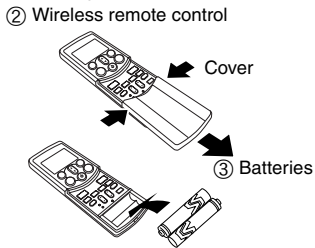

As shown in the figure, position power cord and connecting cable downward, and route it along piping connection port.

For the rear left and left piping

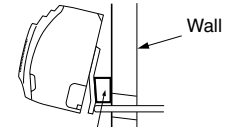

Insert the cushion between the indoor unit and wall, and tilt the indoor unit for better installation work.

Do not allow the drain hose to become slack.

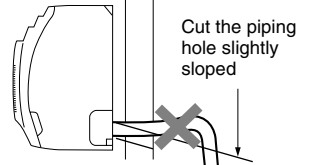

Make sure the drain hose is sloped downward.

The auxiliary piping can be connected at the left, rear left, rear right, right, bottom right or bottom left as shown below.

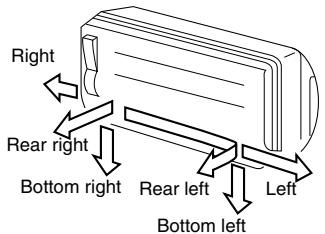

Insulate the refrigerant pipes separately, not together.

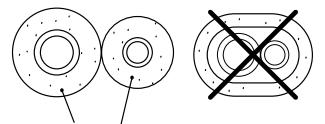

6 mm thick heat resisting polyethylene foam

# 3 OPTIONAL PARTS, ACCESORIES AND TOOLS

## Optional Installation Parts

Part Code	Parts name	Q'ty
A	Refrigerant piping Liquid side: $\phi 6.35$ mm Gas side: $\phi 9.52$ mm	1 ea.
B	Pipe insulating material (polyethylene foam, 6 mm thick)	1
C	Putty, PVC tapes one	1 ea.





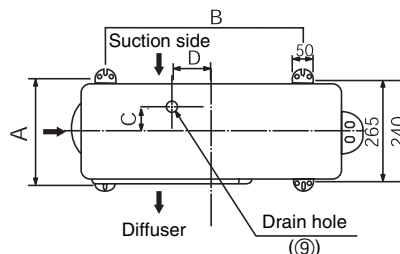

### Attachment bolt arrangement of outdoor unit

- Secure the outdoor unit with the attachment bolts and nuts if the unit is likely to be exposed to a strong wind.
- Use  $\phi 8$  mm or  $\phi 10$  mm anchor bolts and nuts.
- If it is necessary to drain the defrost water, attach drain nipple to the bottom plate of the outdoor unit before installing it.

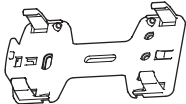

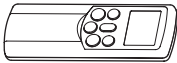
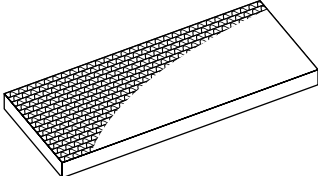
A	B	C	D
310	600	76	115

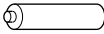
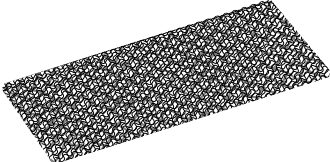
## Accessory and Installation Parts

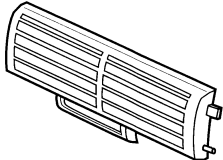
Part No.	Part name (Q'ty)	Part No.	Part name (Q'ty)	Part No.	Part name (Q'ty)			
①	 Installation plate x 1	④	 Remote control holder x 1	⑦	 Mounting screw $\phi 4 \times 25L \times 6$			
②	 Wireless remote control x 1	⑤	 Zeolite-plus filter x 1	⑧	 Flat head wood screw $\phi 3.1 \times 16L \times 2$			
③	 Battery x 2	⑥	 Zeolite-3G filter x 1	⑨	 Drain nipple* x 1 (RAS-10JAVP-E) (RAS-13JAVP-E)			
Others	<table border="1"> <thead> <tr> <th>Name</th> </tr> </thead> <tbody> <tr> <td>Owner's manual</td> </tr> <tr> <td>Installation manual</td> </tr> </tbody> </table>	Name	Owner's manual	Installation manual	<p>This model is not equipped with an extension drain hose.</p> <p><b>Option:</b> For the extension drain hose, use the optionally available RB-821SW or a commercially available one.</p>		⑩	 Dust collecting unit
Name								
Owner's manual								
Installation manual								

Parts marked with asterisk (\*) are packaged with the outdoor unit.







## Installation/Service Tools

### Changes in the product and components

In air conditioners using R410A, in order to prevent any other refrigerant from being accidentally charged, the service port diameter size of the outdoor unit control valve (3 way valve) has been changed. (1/2 UNF 20 threads per inch)

- In order to increase the pressure resisting strength of the refrigerant piping, flare processing diameter and opposing flare nuts sizes have been changed. (for copper pipes with nominal dimensions 1/2 and 5/8)

### New tools for R410A

New tools for R410A	Applicable to R22 model	Changes
Gauge manifold	×	 As the working pressure is high, it is impossible to measure the working pressure using conventional gauges. In order to prevent any other refrigerant from being charged, the port diameters have been changed.
Charge hose	×	 In order to increase pressure resisting strength, hose materials and port sizes have been changed (to 1/2 UNF 20 threads per inch). When purchasing a charge hose, be sure to confirm the port size.
Electronic balance for refrigerant charging	○	 As working pressure is high and gasification speed is fast, it is difficult to read the indicated value by means of charging cylinder, as air bubbles occur.
Torque wrench (nominal dia. 1/2, 5/8)	×	 The size of opposing flare nuts have been increased. Incidentally, a common wrench is used for nominal diameters 1/4 and 3/8.
Flare tool (clutch type)	○	 By increasing the clamp bar's receiving hole size, strength of spring in the tool has been improved.
Gauge for projection adjustment	—	Used when flare is made by using conventional flare tool.
Vacuum pump adapter	○	 Connected to conventional vacuum pump. It is necessary to use an adapter to prevent vacuum pump oil from flowing back into the charge hose. The charge hose connecting part has two ports — one for conventional refrigerant (7/16 UNF 20 threads per inch) and one for R410A. If the vacuum pump oil (mineral) mixes with R410A a sludge may occur and damage the equipment.
Gas leakage detector	×	 Exclusive for HFC refrigerant.

- Incidentally, the “refrigerant cylinder” comes with the refrigerant designation (R410A) and protector coating in the U.S.'s ARI specified rose color (ARI color code: PMS 507).
- Also, the “charge port and packing for refrigerant cylinder” requires 1/2 UNF 20 threads per inch corresponding to the charge hose's port size.



## Mounting the installation plate

For installation of the indoor unit, use the paper pattern on the back.

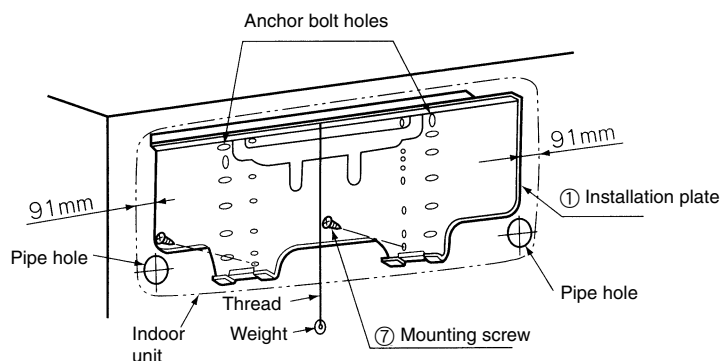

### When the installation plate is directly mounted on the wall

1. Securely fit the installation plate onto the wall by screws with the upper and lower catches, that hold the indoor unit, facing out.
2. To mount the installation plate on a concrete wall use anchor bolts. Drill the anchor bolt holes as illustrated in the above figure.
3. Install the installation plate horizontally and level.

### CAUTION

When installing the installation plate with mounting screws, do not use anchor bolt holes. Otherwise the unit may fall down and result in personal injury and property damage.

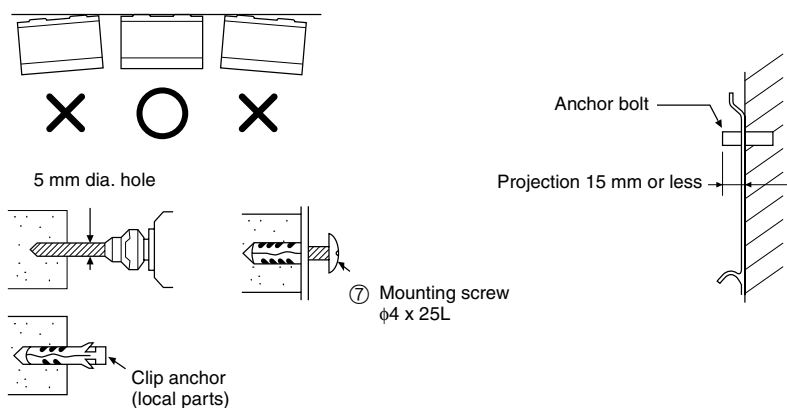

### CAUTION

Failure to securely install the unit may result in personal injury and/or property damage if the unit falls.

- In case of block, brick, concrete or similar type walls, drill 5 mm dia. holes in the wall.
- Insert clip anchors for the ⑦ mounting screws.

### NOTE

- Install the installation plate using between 4 to 6 mounting screws, being sure to secure all four corners.

## Electrical Work

1. The supply voltage must be the same as the rated voltage of the air conditioner.
2. Prepare a power source for the exclusive use of the air conditioner.

### NOTE

- Wire type: More than H07RN-F or 245IEC66 (1.0 mm<sup>2</sup> or more)

## CAUTION

- This appliance can be connected to a main circuit breaker in either of the following two ways.
  - (1) Connection to fixed wiring:  
A switch or circuit breaker which disconnects all poles and has a contact separation of at least 3 mm must be incorporate in the fixed wiring. An approved circuit breaker or switch must used.
  - (2) Connection with power supply plug:  
Attach power supply plug with power cord and plug it into wall outlet. An approved power supply cord and plug must be used.

## NOTE

- Perform wiring work being sure the wire length is long enough.

## Wiring Connection

### How to connect the connecting cable

Wiring the connecting cable can be carried out without removing the front panel.

1. Remove the air inlet grille. Open the air inlet grille upward and pull it toward you.
2. Remove the terminal cover and cord clamp.
3. Insert the connecting cable (or as according to local regulations/codes) into the pipe hole on the wall.
4. Pull the connecting cable through the cable slot on the rear panel so that it protrudes about 15 cm out of the front.
5. Insert the connecting cable fully into the terminal block and secure it tightly with screws.
6. Tightening torque: 1.2 N·m (0.12 kgf·m)
7. Secure the connecting cable with the cord clamp.
8. Attach the terminal cover, rear plate bushing and air inlet grille on the indoor unit.

## CAUTION

- Be sure to refer to the wiring system diagram labeled inside the front panel.
- Check local electrical regulations for any specific wiring instructions or limitations.

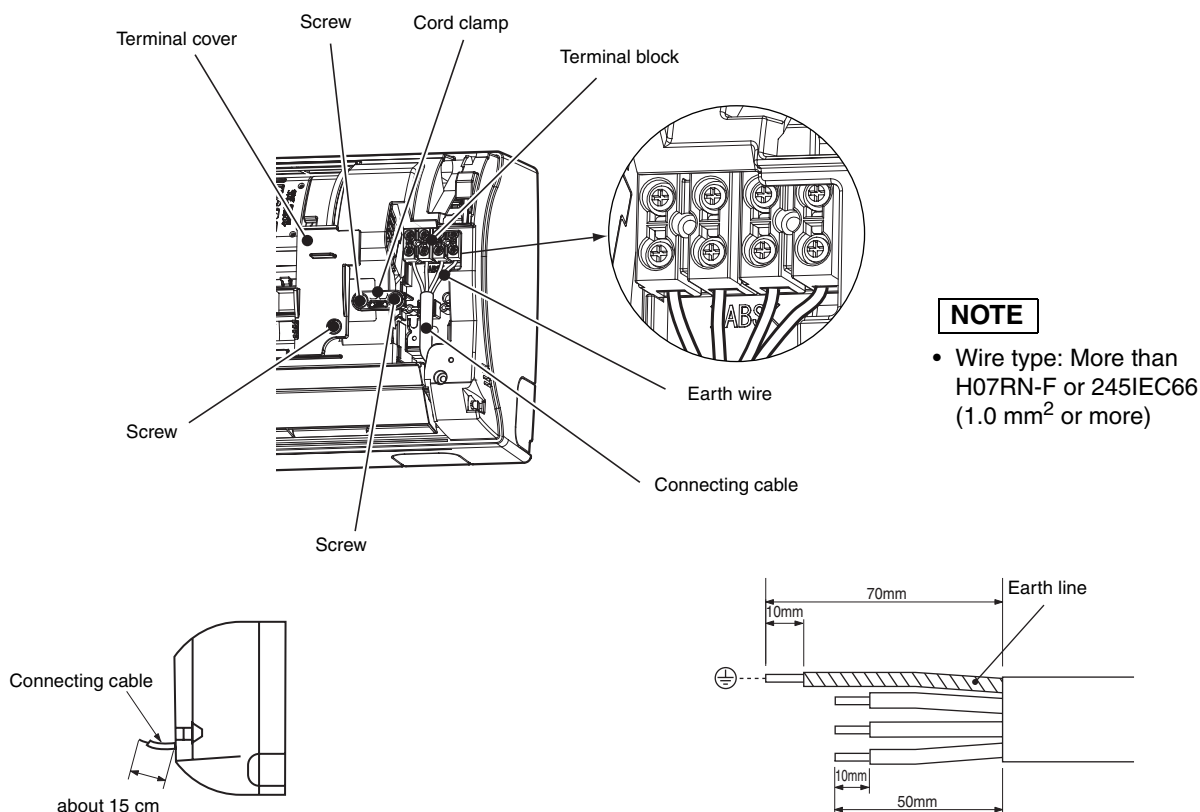

# Piping and Drain Hose Installation

## Piping and drain hose forming

- Since condensation results in machine trouble, make sure to insulate both the connecting pipes separately. (Use polyethylene foam as insulating material.)

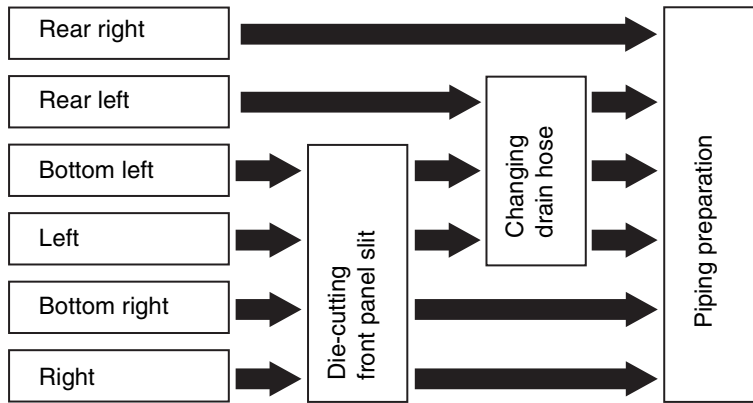

### 1. Die-cutting front panel slit

Cut out the slit on the left or right side of the front panel for the left or right connection and the slit on the bottom left or right side of the front panel for the bottom left or right connection with a pair of nippers.

### 2. Changing drain hose

For left connection, left-bottom connection and rear-left connection's piping, it is necessary to relocate the drain hose and drain cap.

### How to remove the drain cap

Clamp drain cap with needle-nose pliers, and pull out.

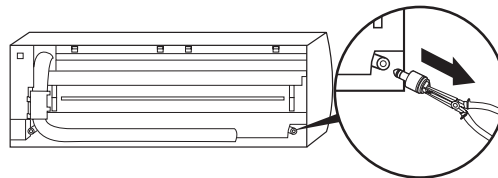

### How to install the drain hose

Firmly insert drain hose connecting part until it comes in contact with the heat insulator.

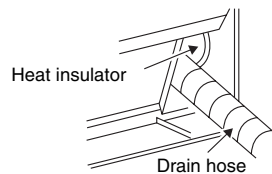

### How to attach the drain cap

1. Insert hexagonal wrench (4 mm).

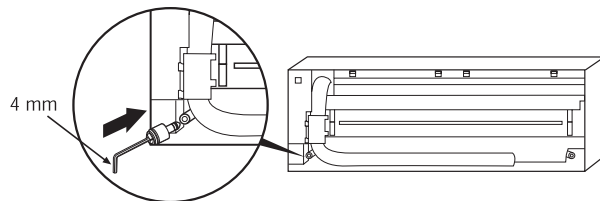

2. Firmly insert drain cap.

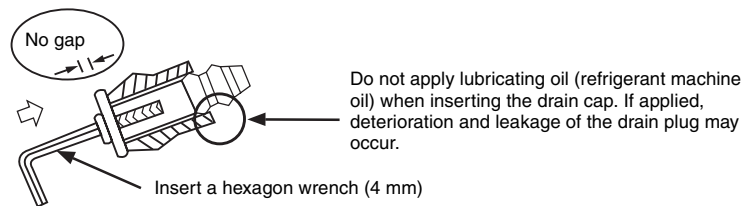

## CAUTION

Securely insert the drain hose and drain cap; otherwise, water may leak.

### In case of right or left piping

- After making slits on the front panel with a knife or similar tool, cut them out with a pair of nippers or an equivalent tool.

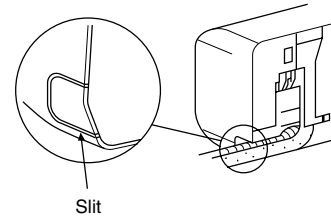

### In case of bottom right or bottom left piping

- After making slits on the front panel with a knife or similar tool, cut them out with a pair of nippers or an equivalent tool.

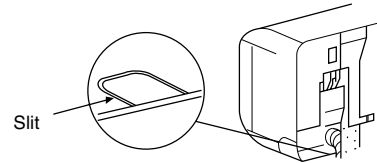

### Left-hand connection with piping

Bend the connecting pipes so that they are positioned within 43 mm above the wall surface. If the connecting pipes are positioned more than 43 mm above the wall surface, the indoor unit may be unstable. When bending the connecting pipe, make sure to use a spring bender to avoid crushing the pipe.

**Bend the connection pipe between a radius of 30 mm ( $\phi 6.35$ ) to 40 mm ( $\phi 9.52$ ).**

**To connect the pipe after installation of the unit (figure)**

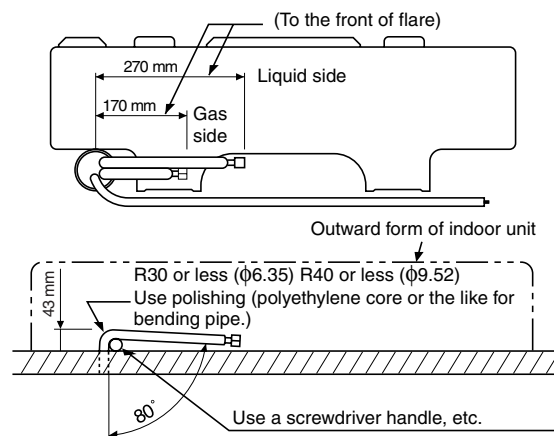

### NOTE

If the pipe is incorrectly bent, the indoor unit may be unstable on the wall.

After passing the connecting pipe through the pipe hole, connect the connecting pipe to the auxiliary pipes and wrap the facing tape around them.

### CAUTION

- Bind the auxiliary pipes (two) and connecting cable with facing tape tightly. In case of leftward piping and rear-leftward piping, bind the auxiliary pipes (two) only with facing tape.

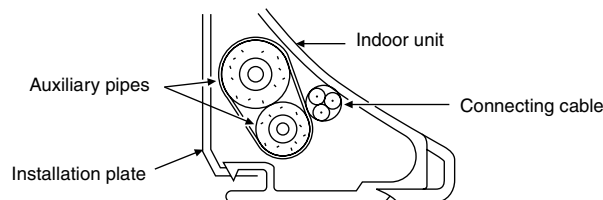

- Carefully arrange the pipes so that none of the pipes stick out of the rear plate of the indoor unit.
- Carefully connect the auxiliary pipes and connecting pipes to each other and cut off the insulating tape wound on the connecting pipe to avoid double-taping at the joint, moreover, seal the joint with the vinyl tape, etc.
- Since condensation can result in machine performance trouble, be sure to insulate both connecting pipes. (Use polyethylene foam as insulating material.)
- When bending a pipe, be careful not to crush it.

## Indoor Unit Installation

1. Pass the pipe through the hole in the wall, and hook the indoor unit on the installation plate at the upper hooks.
2. Swing the indoor unit to right and left to confirm that it is firmly hooked on the installation plate.
3. While pressing the indoor unit onto the wall, hook it at the lower part on the installation plate. Pull the indoor unit toward you to confirm that it is firmly hooked on the installation plate.

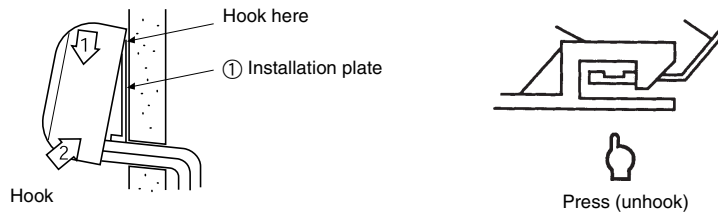

- For detaching the indoor unit from the installation plate pull the indoor unit toward you while pushing the bottom up at the specified places.

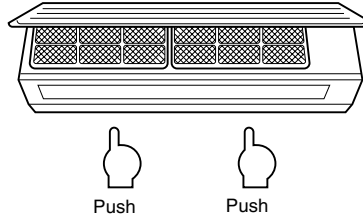

## Drainage

1. Run the drain hose at a downward sloped angle.

### NOTE

- Hole should be made at a slight downward slant on the outdoor side.

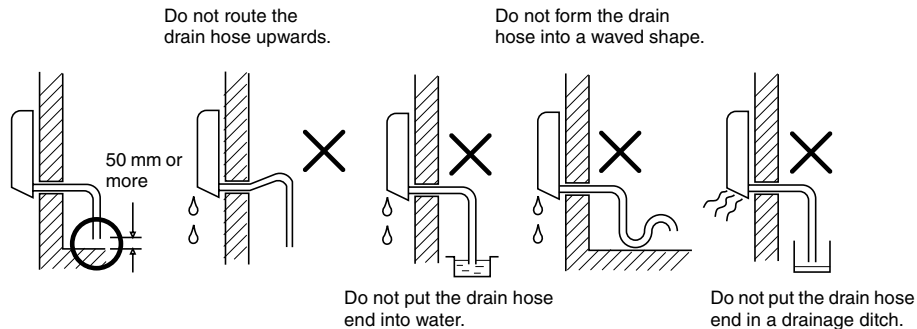

2. Put water in the drain pan and make sure that the water is being drained outside.
3. When connecting extension drain hose, insulate the connection part of extension drain hose with shield pipe.

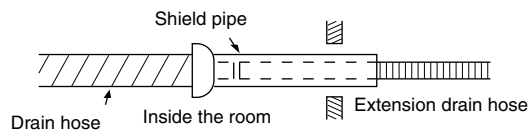

### CAUTION

Install the drain pipe for proper drainage. Improper drainage can result in water dripping inside the room.

This air conditioner has been designed to drain water collected from condensation which forms on the back of the indoor unit, to the drain pan. Therefore, do not locate the power cord and other parts at a height above the drain guide.

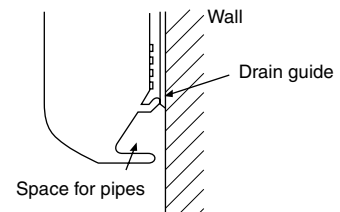

# 5 INSTALLATION OF OUTDOOR UNIT

## Installation Location

- A place which provides enough space around the outdoor unit as shown in the diagram.
- A place which can bear the weight of the outdoor unit and does not allow an increase in noise level and vibration.
- A place where the operation noise and discharged air do not disturb neighbors.
- A place which is not exposed to a strong wind.
- A place free of combustible gases.
- A place which does not block a passageway.
- When the outdoor unit is to be installed in an elevated position, be sure to secure its feet.
- This air conditioner accepts a connection piping length of up to 25 m.
  - There is no need to add refrigerant as long as the length of the connection piping is 15 m or less.
  - You will need to add 20 g of refrigerant per meter of added connection piping for installations requiring connection piping to be between 16 m to 25 m.
- An allowable height level is up to 10 m.
- A place where the drain water does not cause any problems.

## Precautions for Adding Refrigerant

- Use a scale having a precision with at least 10 g per index line when adding the refrigerant. Do not use a bathroom scale or similar instrument.
- Use liquid refrigerant when refilling the refrigerant. Since the refrigerant is in liquid form, it can fill quickly. Therefore, perform the filling operation carefully and insert the refrigerant gradually.

## CAUTION

1. Install the outdoor unit without anything blocking the discharging air.
2. When the outdoor unit is installed in a place always exposed to strong winds like on the coast or on a high story of a building, secure the normal fan operation using a duct or a wind shield.
3. Especially in windy areas, install the unit to prevent the admission of wind.
4. Installation in the following places may result in trouble. Do not install the unit in such places.
  - A place full of machine oil.
  - A saline-place such as the coast.
  - A place full of sulfide gas.
  - A place where high-frequency waves are likely to be generated, such as from audio equipment, welders, and medical equipment.

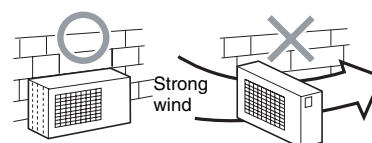

## Refrigerant Piping Connection

### Flaring

1. Cut the pipe with a pipe cutter.

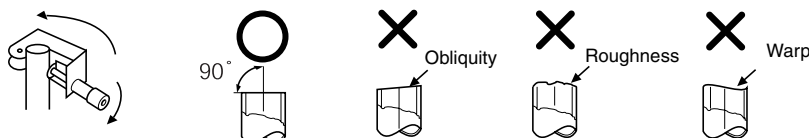

2. Insert a flare nut into the pipe, and flare the pipe.

- Projection margin in flaring: A (Unit: mm)  
Rigid (Clutch type)

Outer dia. of copper pipe	R410A tool used	Conventional tool used
6.35	0 to 0.5	1.0 to 1.5
9.52	0 to 0.5	1.0 to 1.5

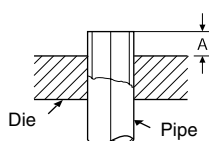

### Imperial (Wing nut type)

Outer dia. of copper pipe	R410A
6.35	1.5 to 2.0
9.52	1.5 to 2.0

**Tighten the connection**

Align the centers of the connecting pipes and tighten the flare nut as much as possible with your fingers. Then tighten the nut with a spanner and torque wrench as shown in the figure.

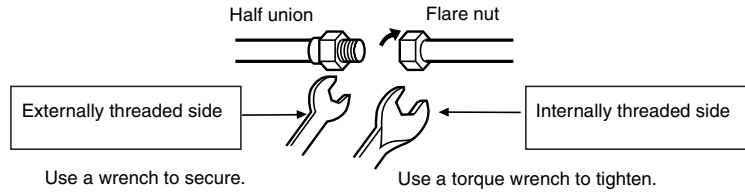

**CAUTION**

- Do not apply excessive force. Otherwise, the nut may break.

(Unit: N·m)

Outer dia. of copper pipe	Tightening torque
φ6.35 mm	14 to 18 (1.4 to 1.8 kgf·m)
φ9.52 mm	33 to 42 (3.3 to 4.2 kgf·m)

- Tightening torque for connection of flare pipe  
The pressure of R410A is higher than R22. (Approx. 1.6 times.) Therefore securely tighten the flare pipes which connect the outdoor unit and the indoor unit with the specified tightening torque using a torque wrench.  
If any flare pipe is incorrectly connected, it may cause not only a gas leakage but also trouble in the refrigeration cycle.

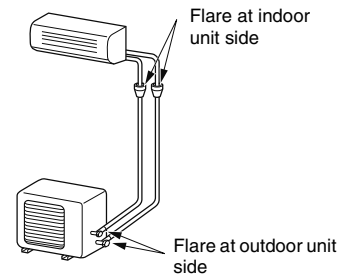

**Shaping pipes**

1. How to shape the pipes  
Shape the pipes along the incased line on the outdoor unit.
2. How to position the pipes  
Put the edges of the pipes to the place with a distance of 85 mm from the incased line.

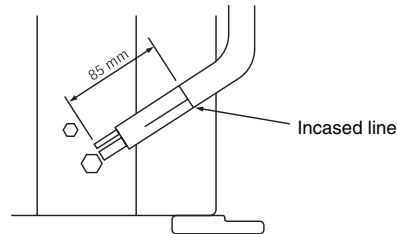

## Evacuating

After the piping has been connected to the indoor unit, perform the air purge.

### AIR PURGE

Evacuate the air in the connecting pipes and in the indoor unit using a vacuum pump. Do not use the refrigerant in the outdoor unit. For details, see the vacuum pump manual.

### Use a vacuum pump

Be sure to use a vacuum pump with counter-flow prevention function so that oil inside the pump does not flow back into the air conditioner pipes when the pump stops. (If oil inside the vacuum pump enters into the air conditioner circuit which uses R410A, trouble with the refrigeration system may develop.)

1. Connect the charge hose from the manifold valve to the service port of the gas side packed valve.
2. Connect the charge hose to the port of the vacuum pump.
3. Open fully the low pressure side handle of the gauge manifold valve.
4. Operate the vacuum pump to begin evacuating. Perform evacuating for about 15 minutes if the piping length is 20 meters (15 minutes for 20 meters) (assuming a pump capacity of 27 liters per minute.) confirm that the compound pressure gauge reading is  $-101$  kPa ( $-76$  cmHg).
5. Close the low pressure valve handle of gauge manifold.
6. Open fully the valve stem of the packed valves (both sides of Gas and Liquid).
7. Remove the charging hose from the service port.
8. Securely tighten the caps on the packed valves.

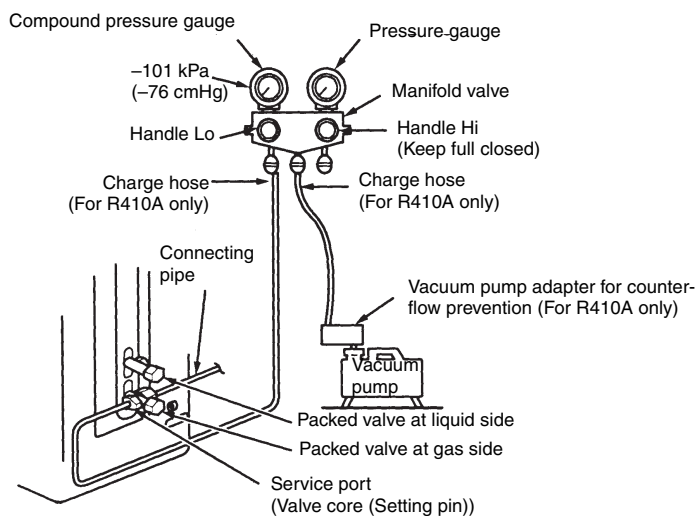

## CAUTION

### IMPORTANT POINTS FOR PIPING WORK

- (1) Keep dust and moisture from entering the pipes.
- (2) Tighten connections carefully (between pipes and unit)
- (3) Evacuate the air in the connecting pipes using a VACUUM PUMP.
- (4) Check for gas leaks at all connections.

### Packed valve handling precautions

- Open the valve stem all the way; but do not try to open it beyond the stopper.
- Securely tighten the valve stem cap with torque in the following table:

Gas side ( $\phi 9.52$ mm)	33 to 42 N·m (3.3 to 4.2 kgf·m)
Liquid side ( $\phi 6.35$ mm)	14 to 18 N·m (1.4 to 1.8 kgf·m)
Service port	14 to 18 N·m (1.4 to 1.8 kgf·m)

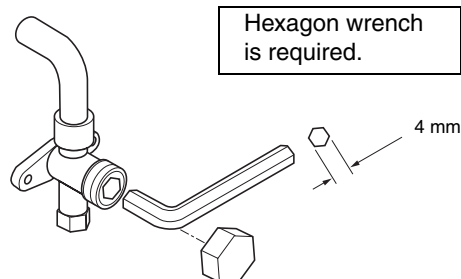

## Wiring Connection

1. Remove the electric parts cover from the outdoor unit.
2. Connect the connecting cable to the terminal as identified by the matching numbers on the terminal block of indoor and outdoor unit.
3. When connecting the connecting cable to the outdoor unit terminal, make a loop as shown on installation diagram of indoor and outdoor unit, to prevent water from entering the outdoor unit.
4. Insulate the unused parts (conductors) from water entering in the outdoor unit. Locate them so that they do not touch any electrical or metal parts.

### Stripping length of connecting cable

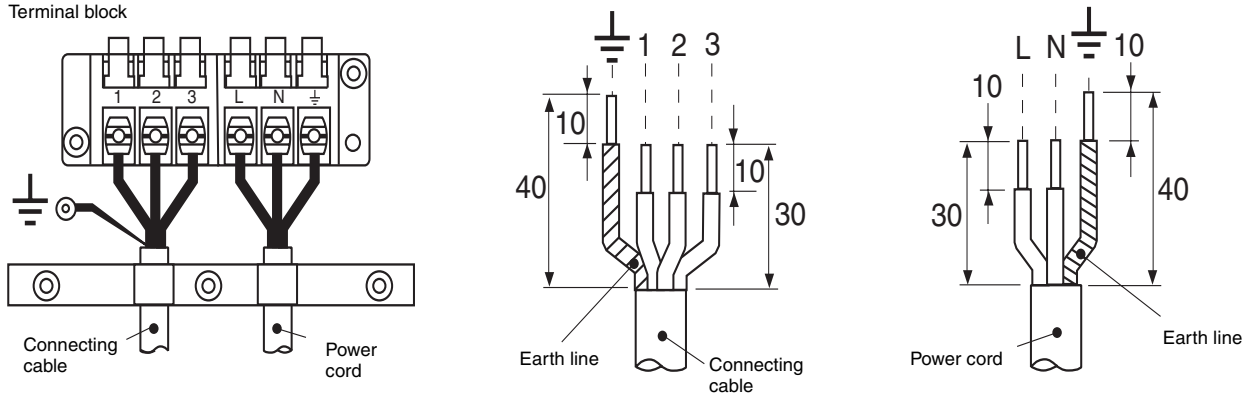

Model	RAS-10JKVP-E RAS-10JKCVP	RAS-13JKVP-E RAS-13JKCVP
Power source	220–240V~, 50Hz 220V~, 60Hz	
Maximum running current	10A	11A
Installation fuse rating	25A (D type  )	
Power cord	H07RN-F or 245IEC66 (1.5 mm <sup>2</sup> or more)	
Connecting cable	Wire type: More than H07RN-F or 245IEC66 (1.0 mm <sup>2</sup> or more)	

### CAUTION

- Incorrect wiring connection may cause electrical parts to burn out.
- Be sure to comply with local regulations/codes when running the wire from outdoor unit to indoor unit. (Size of wire and wiring method etc.)
- Every wire must be securely connected.
- This installation fuse (25A D type ) must be used for the power supply line. (RAS-10JKVP-E and RAS-13JKVP-E)
- If incorrect or incomplete wiring is carried out, fire or smoke may result.
- Prepare the power supply for the exclusive use of the air conditioner.
- This product can be connected to the main breaker.

Connection to fixed wiring: A switch which disconnects all poles and has a contact separation of at least 3 mm must be incorporated in the fixed wiring when connecting to a main breaker circuit.

## 6 TEST OPERATION

### Gas Leak Test

- Check the flare nut connections for gas leaks with a gas leak detector and/or soapy water.

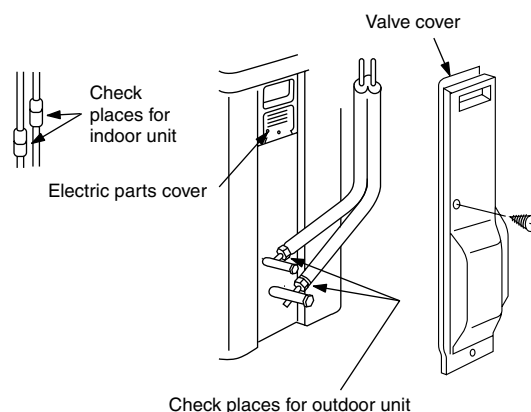

### Test Operation

To test the system, press and hold RESET button for 10 sec.  
(There will be one short beep.)

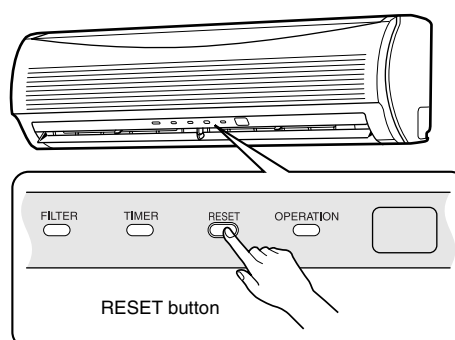

### Auto Restart Setting

This product is designed so that, after a power failure, it can restart automatically in the same operating mode as before the power failure.

### INFORMATION

The product was shipped with Auto Restart function in the OFF position. Turn it ON as required.

#### How to set the Auto Restart

- Press and hold the RESET button for about 3 seconds. After 3 seconds, three short electric beeps will be heard to inform you that the Auto Restart has been selected.
- To cancel the Auto Restart, follow the steps described in the section Auto Restart Function of the Owner's Manual.

### Remote Control Selector Switch Setting

#### Remote control selector switch

- If two indoor units are installed in the same room or adjoining rooms, the second unit can inadvertently receive a remote control signal and start operation when operating the first unit. This can be prevented by setting one of the indoor units and the corresponding remote control to the B setting (the A setting is the default setting).

1. Setting the remote control switch on the main unit
  - Remove the front panel, and then set the selector switch to "B".
  - After making the switch setting, remount the front panel.
2. Setting the remote control switch on the remote control
  - Insert dry-cell batteries, and press the RESET button.
  - While holding down the CHECK button with a pointed object, press the FIX button so that "B" is displayed at the right of the temperature indicator.
3. Check that the indoor unit can be operated by the modified remote control.

Position of remote control selector switch

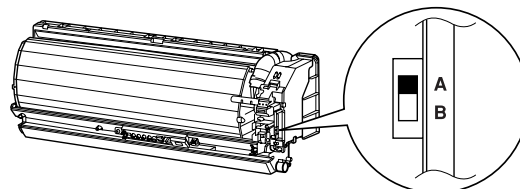

**TOSHIBA CARRIER CORPORATION**  
336, TADEWARA FUJI-SHI, SHIZUOKA-KEN, 416-8521, JAPAN