

# TOSHIBA

## OWNER'S MANUAL

MODE D'EMPLOI

BEDIENUNGSANLEITUNG

MANUALE DI ISTRUZIONI

MANUAL DEL PROPIETARIO

ΟΔΗΓΙΕΣ ΧΡΗΣΗΣ

MANUAL DO UTILIZADOR

BRUKSANVISNING

ИНСТРУКЦИЯ ДЛЯ ПОЛЬЗОВАТЕЛЯ

# AIR CONDITIONER (SPLIT TYPE)

CLIMATISEUR (TYPE SEPARÉ)

KLIMAGERÄT (GETEILTE AUSFÜHRUNG)

CONDIZIONATORE D'ARIA (TIPO SPLIT)

ACONDICIONADOR DE AIRE (TIPO SEPARADO)

ΚΛΙΜΑΤΙΣΤΙΚΗ ΜΟΝΑΔΑ (ΔΙΑΙΡΟΥΜΕΝΟΥ ΤΥΠΟΥ)

AR CONDICIONADO (TIPO SPLIT)

LUFTKONDITIONERING (SPLITTYP)

КОНДИЦИОНЕР (РАЗДЕЛИТЕЛЬНЫЙ ТИП)

For general public use

Pour utilisation grand public

Für allgemeine Verwendung

Per l'uso in generale

Para el uso público general

Για γενική δημόσια χρήση

Para utilização geral

För allmän användning

Для общего бытового использования

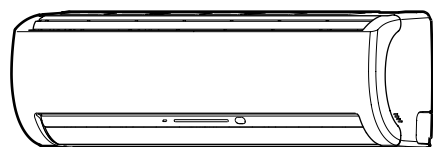

Indoor Unit Unité intérieure Innenraumgerät Unità interna Unidad interior Εσωτερική μονάδα Unidade interior Innedel Внутренний блок	Outdoor Unit Unité extérieure Außengerät Unità esterna Unidad exterior Εξωτερική μονάδα Unidade exterior Utedel Наружный блок
RAS-B10GKVP-E RAS-B13GKVP-E RAS-B16GKVP-E	RAS-10GAVP-E RAS-13GAVP-E RAS-16GAVP-E RAS-M14GAV-E RAS-M18GAV-E
RAS-M10GKCVP-E RAS-M13GKCVP-E RAS-M16GKCVP-E	RAS-M14GACV-E RAS-M18GACV-E

Thank you for purchasing this TOSHIBA Air Conditioner. Please read this owner's manual carefully before using your Air Conditioner.

Avant tout, merci d'avoir porté votre choix sur un climatiseur TOSHIBA. Veuillez lire attentivement ce mode d'emploi avant de mettre en service le climatiseur.

Wir danken Ihnen für den Kauf dieses TOSHIBA-Klimageräts. Lesen Sie die Bedienungsanleitung sorgfältig durch, bevor Sie das Gerät in Betrieb nehmen.

Grazie per aver acquistato questo Condizionatore d'Aria TOSHIBA. Prima di usare il Condizionatore d'Aria, si consiglia di leggere con attenzione il presente manuale.

Gracias por adquirir este acondicionador de aire TOSHIBA. Lea este manual del propietario detenidamente antes de utilizar su acondicionador de aire.

Ευχαριστούμε για την αγορά αυτού του κλιματιστικού της TOSHIBA. Παρακαλείστε να διαβάσετε προσεκτικά τις οδηγίες χρήσης πριν χρησιμοποιήσετε την κλιματιστική μονάδα σας.

Obrigado por ter adquirido este ar condicionado da TOSHIBA. Leia atentamente este manual do utilizador antes de utilizar o ar condicionado.

Tack för ditt inköp av denna TOSHIBA luftkonditionering. Läs den här bruksanvisningen noga innan du använder din luftkonditionering.

Благодарим Вас за покупку этого кондиционера фирмы TOSHIBA. Перед использованием Вашего кондиционера прочитайте, пожалуйста, внимательно эту инструкцию для пользователя.

ENGLISH

FRANÇAIS

DEUTSCH

ITALIANO

ESPAÑOL

ΕΛΛΗΝΙΚΑ

PORTUGUÊS

SVENSKA

РУССКИЙ ЯЗЫК

# CONTENTS/SOMMAIRE

## ENGLISH

ACCESSORIES.....	1
SAFETY PRECAUTIONS.....	1
NAMES OF PARTS.....	3
NAMES AND FUNCTIONS OF INDICATORS AND CONTROLS ON INDOOR UNIT.....	3
REMOTE CONTROL AND ITS FUNCTIONS.....	4
NAMES AND FUNCTIONS OF INDICATORS ON REMOTE CONTROL.....	5
PREPARATION AND CHECK BEFORE USE.....	5
USING THE REMOTE CONTROL.....	7
AUTOMATIC OPERATION.....	8
AUTOMATIC OPERATION (AUTO CHANGEOVER).....	8
COOLING/HEATING OPERATION.....	9
DRY OPERATION.....	9
FAN ONLY OPERATION (cooling-only models only).....	9
PURE OPERATION.....	10
Hi POWER OPERATION.....	11
TIMER OPERATION.....	11
MEMORY/PRESET OPERATION.....	13
ADJUSTING AIR FLOW DIRECTION.....	14
AUTO RESTART OPERATION.....	15
HOW THE AIR CONDITIONER WORKS.....	16
TEMPORARY OPERATION.....	17
CLEANING OPERATION.....	17
USUAL MAINTENANCE.....	18
SPECIAL MAINTENANCE.....	20
AIR CONDITIONER OPERATION AND PERFORMANCE.....	23
TROUBLESHOOTING.....	24
SPECIFICATIONS.....	27
TROUBLESHOOTING (Remote Control).....	28

## FRANÇAIS

ACCESSOIRES.....	1
MESURES DE SECURITE.....	1
NOM ET FONCTION DES TEMOINS ET COMMANDES DE L'UNITE INTERIEURE.....	3
TELECOMMANDE ET SES FONCTIONS.....	4
NOM ET FONCTION DES INDICATEURS DE LA TELECOMMANDE.....	5
PREPARATION ET VERIFICATION AVANT UTILISATION.....	5
UTILISATION DE LA TELECOMMANDE.....	7
FONCTIONNEMENT AUTOMATIQUE.....	8
FONCTIONNEMENT AUTOMATIQUE (PERMUTATION AUTOMATIQUE).....	8
REFROIDISSEMENT/CHAUFFAGE.....	9
DESHUMIDIFICATION.....	9
VENTILATEUR SEULEMENT (modèles refroidissement seulement).....	9
MODE PURE.....	10
MODE Hi POWER.....	11
MODE MINUTERIE.....	11
MODE MEMOIRE/PREREGLAGE.....	13
REGLAGE DU SENS DU FLUX D'AIR.....	14
FONCTION DE REDEMARRAGE AUTOMATIQUE.....	15
COMMENT LE CLIMATISEUR FONCTIONNE.....	16
FONCTIONNEMENT TEMPORAIRE.....	17
OPERATION DE NETTOYAGE.....	17
ENTRETIEN REGULIER.....	18
ENTRETIEN SPECIAL.....	20
FONCTIONNEMENT ET PERFORMANCES DU CLIMATISEUR.....	23
DEPISTAGE DES PANNES.....	24
CARACTERISTIQUES TECHNIQUES.....	27
DEPISTAGE DES PANNES (Télécommande).....	28

### About indoor unit and outdoor unit combinations

- The **RAS-B10GKVP-E**, **RAS-B13GKVP-E** and **RAS-B16GKVP-E** indoor units can be connected to a single outdoor unit or a multi outdoor unit.

#### For single unit connection

Use the following combinations.

**RAS-B10GKVP-E/RAS-10GAVP-E**

**RAS-B13GKVP-E/RAS-13GAVP-E**

**RAS-B16GKVP-E/RAS-16GAVP-E**

#### For multi unit connection

Refer to the specifications included with the multi outdoor unit.

- The **RAS-M10GKCVP-E**, **RAS-M13GKCVP-E** and **RAS-M16GKCVP-E** indoor units can be connected to a multi outdoor unit. Refer to the specifications included with the multi outdoor unit.

### About indoor unit model names

#### Heat pump models

(**RAS-B10GKVP-E**, **RAS-B13GKVP-E** and **RAS-B16GKVP-E**)

These indoor units can perform both cooling and heating operation.

#### Cooling-only models

(**RAS-M10GKCVP-E**, **RAS-M13GKCVP-E** and

**RAS-M16GKCVP-E**)

These indoor units are cooling-only models, and cannot perform heating operation.

### Sur les combinaisons d'unités intérieure et extérieure

- Les unités intérieures **RAS-B10GKVP-E**, **RAS-B13GKVP-E** et **RAS-B16GKVP-E** peuvent être raccordées à une seule unité extérieure ou à une unité extérieure multiple.

#### Pour un raccordement à une seule unité

Utilisez les combinaisons suivantes.

**RAS-B10GKVP-E/RAS-10GAVP-E**

**RAS-B13GKVP-E/RAS-13GAVP-E**

**RAS-B16GKVP-E/RAS-16GAVP-E**

#### Pour un raccordement à une unité multiple

Reportez-vous aux caractéristiques techniques fournies avec l'unité extérieure multiple.

- Les unités intérieures **RAS-M10GKCVP-E**, **RAS-M13GKCVP-E** et **RAS-M16GKCVP-E** peuvent être raccordées à une unité extérieure multiple. Reportez-vous aux caractéristiques techniques fournies avec l'unité extérieure multiple.

### Sur les noms des modèles d'unité intérieure

#### Modèles pompe à chaleur

(**RAS-B10GKVP-E**, **RAS-B13GKVP-E** et **RAS-B16GKVP-E**)

Ces unités intérieures peuvent effectuer des opérations de refroidissement et de chauffage.

#### Modèles refroidissement seulement

(**RAS-M10GKCVP-E**, **RAS-M13GKCVP-E** et **RAS-M16GKCVP-E**)

Ces unités intérieures sont des modèles refroidissement seulement et elles ne peuvent pas effectuer des opérations de chauffage.

Remote control

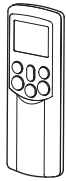

Remote control holder



Batteries (two)

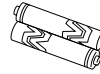

Zeolite-plus filter

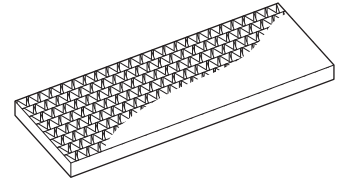

## SAFETY PRECAUTIONS

### DANGER

- DO NOT ATTEMPT TO INSTALL THIS UNIT BY YOURSELF. THIS UNIT REQUIRES A QUALIFIED INSTALLER.
- DO NOT ATTEMPT TO REPAIR THE UNIT BY YOURSELF. THIS UNIT HAS NO COMPONENTS WHICH YOU CAN REPAIR.
- OPENING OR REMOVING THE COVER WILL EXPOSE YOU TO DANGEROUS VOLTAGES.
- TURNING OFF THE POWER SUPPLY WILL NOT PREVENT POTENTIAL ELECTRIC SHOCK.



### WARNING ⚠

#### INSTALLATION WARNINGS

- Be sure to ask a dealer or a store specialized in electric work to install the air conditioner.
- If the air conditioner is improperly installed by yourself, it can cause some problems such as water leaks, electric shock, fire, and so on.
- Be sure to always ground the air conditioner.
- Do not connect the ground wire to gas pipes, water pipes, lightning rods or ground wires of telephones. If the air conditioner is improperly grounded, it can cause an electric shock.

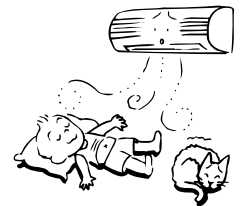

### CAUTION

#### TO DISCONNECT THE APPLIANCE FROM THE MAIN POWER SUPPLY

This appliance must be connected to the main power supply by a circuit breaker or a switch with a contact separation of at least 3 mm.

The installation fuse (25A D type ) must be used for the power supply line of this air conditioner.

#### OPERATION WARNINGS

- Avoid cooling the room too strongly or exposing the human body to cool wind for a long time because it can be detrimental to your health.
- Never insert fingers or sticks into the air outlet and air inlet to avoid getting injured and damaging the machine because there are fans running at a high speed inside both the air inlet and air outlet.
- When you notice something unusual with the air conditioner (such as a burning smell or weak cooling power), immediately turn off the main switch and the circuit breaker from the main power supply to stop the air conditioner, and contact the dealer.
- If the air conditioner is continuously operated when something is wrong, it can cause machine failure, electric shock, fire, and so on.
- Do not spill water or other liquid on the indoor unit. If the unit is wet, it can cause an electric shock.

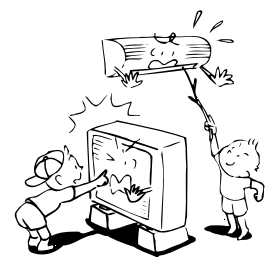

#### MOVEMENT AND REPAIR WARNINGS

- Do not attempt to move or repair the unit by yourself.
- Since there is high voltage inside the unit, you can get an electric shock when removing the cover and main unit.
- Always ask the dealer to move the air conditioner for re-installing it in another place. If it is improperly installed, it can cause electric shock or fire.
- Whenever the air conditioner needs repairs, request repairs from the dealer.  
If the air conditioner is repaired improperly it can cause an electric shock or fire.



## CAUTION

### INSTALLATION CAUTIONS

- Securely lay the drain hose for the best draining results.
- Incorrect drainage can cause flooding in the house and furniture to get wet.
- Be sure to connect the air conditioner to a dedicated power supply having the rated voltage. Otherwise, the unit can break down or cause a fire.
- Do not install the unit in a place where inflammable gas can leak.
- A fire can result if inflammable gas accumulates around the unit.
- The indoor unit shall be installed so that the top of the indoor unit is at least 2 m in height. Also, avoid putting anything on the top of the indoor unit.

### OPERATION CAUTIONS

- Carefully read this manual before starting the air conditioner. The manual includes a lot of important information for daily operation.
- Do not use this air conditioner for other purposes such as preserving food, precision instruments, art objects, breeding animals, or growing potted plants.
- Do not install this air conditioner in a special-purpose room such as a ship or any kind of vehicle. Doing so could harm machine performance.
- Avoid exposing potted plants and animals to wind from the air conditioner because it harms their health and growth.
- When the air conditioner is operated together with a combustion device in the same place, pay careful attention to ventilation and let fresh air into the room. Poor ventilation can cause an oxygen shortage.
- When the air conditioner is used in a closed room, pay careful attention to the ventilation of the room. Poor ventilation can cause an oxygen shortage.
- Do not touch the operation buttons with wet hands. Doing so could cause an electric shock.
- Do not place any combustion device in a place where it is directly exposed to wind from the air conditioner. Doing so could cause incomplete combustion.
- When the air conditioner will not be used for an extended period of time, turn off the main switch or the circuit breaker for added safety. Disconnecting from the power supply protects the unit from lightning and power surges.
- Do not put a container with water such as a vase on the unit because water can enter into the unit and cause an electric shock due to deterioration in the electric insulation.
- Check the concrete blocks underneath the outdoor unit occasionally. If the base is left damaged or deteriorated, the unit can topple over and could possibly cause an injury.
- Do not wash the unit with water. This could cause an electric shock.
- Do not use alcohol, benzene, thinner, glass cleaner, polishing powder or other solvent for cleaning the unit because they can deteriorate and damage the air conditioner.
- Before cleaning the unit, be sure to turn off the main switch or circuit breaker to prevent injuries from the electric fan running inside.
- For details of the cleaning method, refer to "USUAL MAINTENANCE" and "SPECIAL MAINTENANCE" on pages 18 to 22.
- Do not put anything on or step on the indoor unit and outdoor unit. If you do so, it can topple over and cause an injury.
- To allow the air conditioner to operate at maximum performance, operate within the operating temperature range specified in the instructions. Failure to do so can cause a malfunction, break down, or water to leak from the unit.

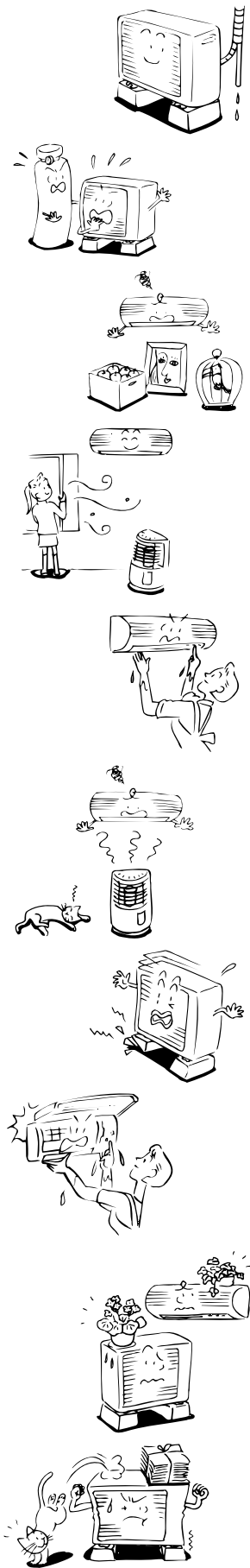

# NAMES OF PARTS

## Outdoor unit

- ① Drain hose, refrigerant connecting pipe and electric wires
- ② Air inlet (Side and rear)
- ③ Air outlet

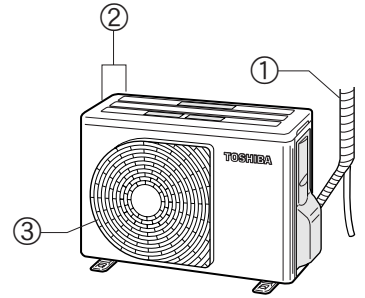

## Indoor unit

- ④ Room temperature sensor
- ⑤ Front panel
- ⑥ Air inlet grille
- ⑦ Air filter
- ⑧ Air outlet
- ⑨ Horizontal air flow louver
- ⑩ Vertical air flow louver
- ⑪ Display panel
- ⑫ Infrared signal receiver
- ⑬ Remote control
- ⑭ Plasma pure filter
- ⑮ Zeolite-plus filter
- ⑯ Air ionizer

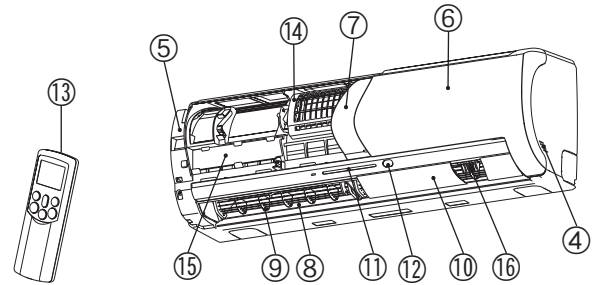

# NAMES AND FUNCTIONS OF INDICATORS AND CONTROLS ON INDOOR UNIT

## Display panel

The operating states are shown below.

- ① RESET button
- ② FILTER indicator (Orange)
- ③ TIMER indicator (Yellow)
- ④ PURE indicator (Blue)
- ⑤ OPERATION indicator (Green)

The operation indicators flash rapidly (five times per second) when a safety protection feature is activated.

- ⑥ S.CLEAN indicator (Green)  
When the unit shuts down after having operated for 10 or more minutes in the cooling or dry mode, the cleaning operation is started automatically, and the S.CLEAN indicator on the unit's display panel turns on.



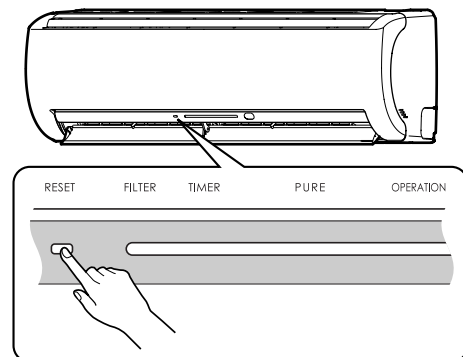
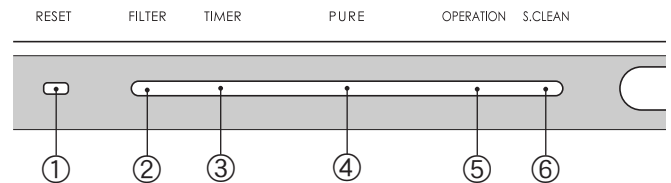

## RESET button

If you misplace or lose the remote control or its batteries are used up, push the RESET button.

1. Push the RESET button to start the automatic operation (AUTO). Push this button again to stop operation.



# REMOTE CONTROL AND ITS FUNCTIONS

- ① **Infrared signal transmitter**  
Transmits signals to the indoor unit.
- ② **⏻ button**  
Press the button to start operation. (A receiving beep is heard.) Press the button again to stop operation. (A receiving beep is heard.)  
If no receiving sound is heard from the indoor unit, press the button twice.
- ③ **Mode select button (MODE)**  
Press this button to select a mode. Each time you press the button, the modes cycle in order from A: Auto changeover control, ☀: COOL, ☁: DRY, ☀: HEAT (heat pump models only), 🌀: FAN ONLY (cooling-only models only) and back to A.  
(A receiving beep is heard.)
- ④ **Temperature button (TEMP)**  
▲ ... The temperature setting is increased to 30°C.  
▼ ... The temperature setting is reduced to 17°C.  
(A receiving beep is heard.)
- ⑤ **Fan speed button (FAN)**  
Press this button to select the fan speed. When you select AUTO, the fan speed is automatically adjusted according to the room temperature. You can also manually select the desired fan speed from five available settings.  
(LOW —, LOW+ —, MED —, MED+ —, HIGH —) (A receiving beep is heard.)
- ⑥ **Auto louver button (SWING)**  
Press this button to swing the louver. (A receiving beep is heard.)  
Press the button again to stop the louver from swinging. (A receiving beep is heard.) (☞ see page 14.)
- ⑦ **Set louver button (FIX)**  
Press this button to adjust the air flow direction. (A receiving beep is heard.) (☞ see page 14.)
- ⑧ **ON timer button (ON)**  
Use this button to change the clock and ON timer times.  
  
To move up the time, press ▲ of the ON  button.  
  
To move down the time, press ▼ of the ON  button.
- ⑨ **OFF timer button (OFF)**  
Use this button to change the OFF timer times.  
  
To move up the time, press ▲ of the OFF  button.  
  
To move down the time, press ▼ of the OFF  button.
- ⑩ **Reserve button (SET)**  
Press this button to store the time settings. (A receiving beep is heard.)
- ⑪ **Cancel button (CLR)**  
Press this button to cancel the ON timer and OFF timer. (A receiving beep is heard.)
- ⑫ **High power button (Hi POWER)**  
Press this button to start high power operation. (☞ see page 16.)
- ⑬ **Memory button (MEMO)**  
Press this button to ready for storing the settings.  
Hold down the button for more than 3 seconds to store the setting indicated on the remote control and until the **P** mark is displayed. (☞ see page 13.)
- ⑭ **Automatic operation button (AUTO)**  
Press this button to operate the air conditioner automatically.  
(A receiving beep is heard.) (☞ see page 16.)
- ⑮ **Economy button (ECO)**  
Press this button to operate the air conditioner economically. (☞ see page 16.)
- ⑯ **PRESET button**  
Press this button to operate the air conditioner according to the settings stored using the MEMO button. (☞ see page 13.)
- ⑰ **PURE button (PURE)**  
Press this button to start the electrical air purifying operation.  
Press the button again to stop operation.
- ⑱ **Sleep timer button (SLEEP)**  
Press this button to start the sleep timer (OFF timer) operation.  
You can select the OFF timer time from among four settings (1, 3, 5 or 9 hours).

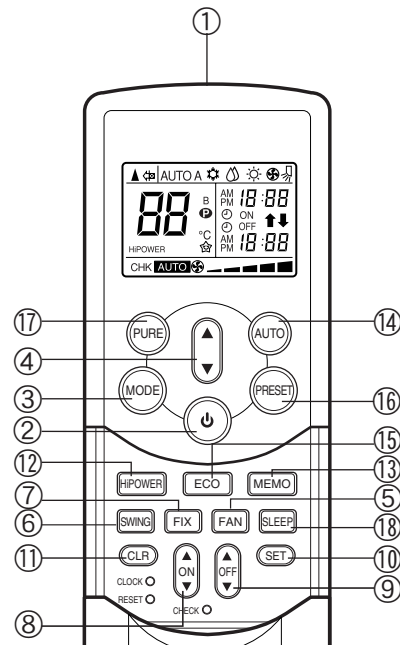

# NAMES AND FUNCTIONS OF INDICATORS ON REMOTE CONTROL

## Display

All indicators, except for the clock time indicator, are displayed by pressing the  button.

- ① **Transmission mark**  
This transmission mark (▲) indicates when the remote control transmits signals to the indoor unit.
- ② **Mode indicator**  
Indicates the current operation mode.
  - Heat pump models  
(AUTO: Automatic control, A: Auto changeover control, ❄️: COOL, 💧: DRY, ☀️: HEAT)
  - Cooling-only models  
(AUTO: Automatic control, A: Auto changeover control, ❄️: COOL, 💧: DRY, 🌀: FAN ONLY)
- ③ **Temperature indicator**  
Indicates the temperature setting (17°C to 30°C).
- ④ **PURE indicator**  
Shows that the electrical air purifying operation is in progress.
- ⑤ **FAN speed indicator**  
Indicates the selected fan speed. AUTO or one of five fan speed levels (LOW —, LOW+ — —, MED — — —, MED+ — — — —, HIGH — — — — —) can be shown. Indicates AUTO when the operating mode is either AUTO or 💧: DRY.
- ⑥ **TIMER and clock time indicator**  
The time setting for timer operation or the clock time is indicated. The current time is always indicated except during TIMER operation.
- ⑦ **Hi POWER indicator**  
Indicates when Hi POWER operation starts. Press the Hi POWER button to start and press it again to stop operation.
- ⑧ **Ⓜ️ (MEMORY) indicator**  
Flashes for 3 seconds when the MEMO button is pressed during operation. The Ⓜ️ mark is shown when holding down the button for more than 3 seconds while the mark is flashing. Press another button to turn off the mark.
- ⑨ **ECO indicator**  
Indicates when the ECO is activated. Press the ECO button to start and press it again to stop operation.
- ⑩ **A. B change indicator remote control**
  - When the remote control switching function is set, “B” appears in the remote control display. (When the remote control setting is “A”, there is no indication at this position.)

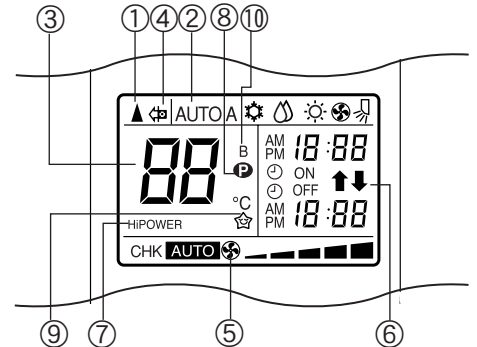

• In the illustration, all indicators are shown for purposes of explanation. During operation, only the relevant indicators are shown on the remote control.

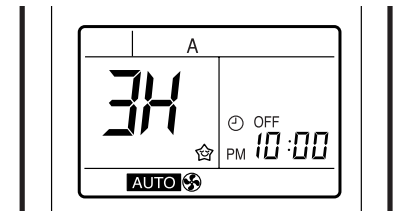

**Remote control switching function**

- If two indoor units are installed in the same room or adjoining rooms, both units may start and stop at the same time when the remote control is operated. This can be prevented by setting the switching function so that each indoor unit is operated only by the corresponding remote control.
- To use the remote control switching function, contact the air conditioner dealer or the installation company.

# PREPARATION AND CHECK BEFORE USE

## Loading the remote control batteries

- ① **Remove the cover, and insert the batteries.**
- ② **Press the RESET button.**  
The clock time indicator flashes. Adjust the clock. Reattach the cover.

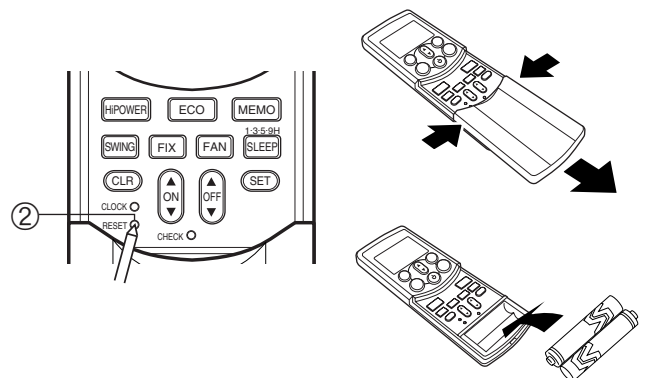

## Batteries

- To replace the batteries, use two new batteries (AAA type).
- The batteries will last about one year under normal usage.
- Replace the batteries if there is no receiving beep from the indoor unit or when the air conditioner cannot be operated using the remote control.
- To avoid malfunctions due to battery leakage, remove the batteries when not using the remote control for more than one month.
- Slide off the cover while pressing the sides.

## Battery replacement

Be careful not to reverse the (+) position and the (-) position.

## Setting the clock

Before you start operating the air conditioner, set the clock of the remote control using the procedures given in this section. The clock panel on the remote control will indicate the time regardless of whether the air conditioner is in use or not.

## Initial setting

When batteries are inserted in the remote control, the clock panel displays AM 0:00 and flashes.

### ① ON button

Press the ON  button to set the current time.

Each press of the ON button changes the time in one minute increments. Holding down the ON button changes the time in ten minute increments.

### ② SET button

Press the SET  button.

The current time is displayed and the clock starts.

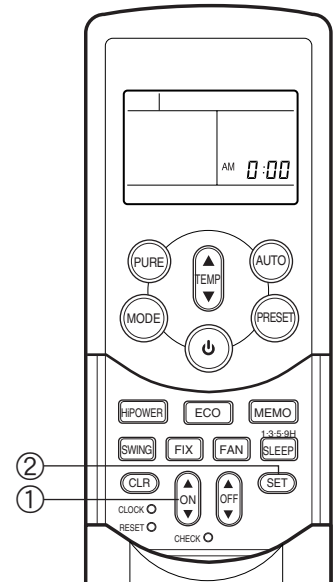

## Adjusting the clock

### ① CLOCK button

Press the CLOCK button.

The clock time indicator flashes.

### ② ON button

Press the ON  button to set the current time.

Each press of the ON button changes the time in one minute increments.

Holding down the ON button changes the time in ten minute increments.

### ③ SET button

Press the SET  button.

The current time is displayed and the clock starts.

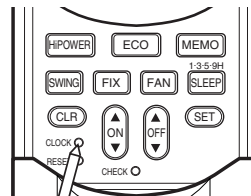

Push CLOCK

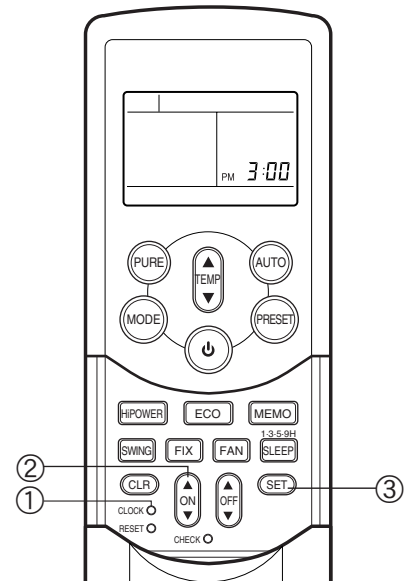

**Preparing the filters**

- ① Open the air inlet grille, and remove the air filters.
- ② Attach the supplied Zeolite-plus filter.

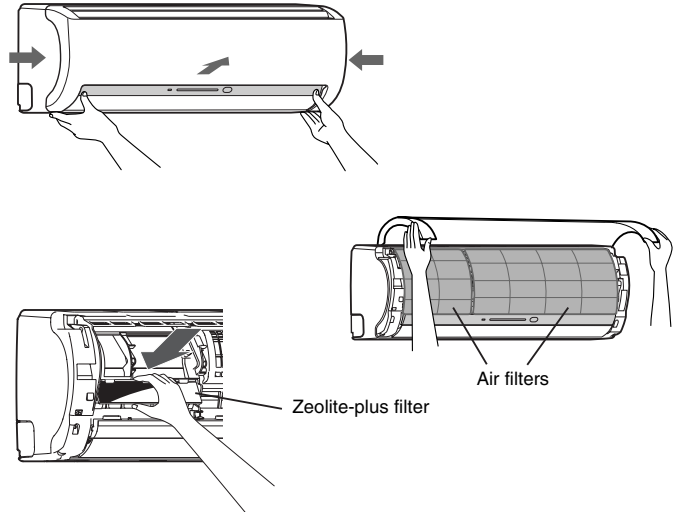

**USING THE REMOTE CONTROL**

**CAUTION**

- The air conditioner will not operate if curtains, doors or other objects block the signals from the remote control to the indoor unit.
- Be careful that liquids do not spill onto the remote control.
- Do not expose the remote control to direct sunlight or heat.  
If the infrared signal receiver on the indoor unit is exposed to direct sunlight, the air conditioner may not function properly. Use curtains to prevent sunlight from reaching the receiver.
- Signals may not be properly received, if the room using the air conditioner has fluorescent lighting with electronic starters. If you are planning on using fluorescent lamps, consult with your local dealer.
- If other electrical appliances are activated by the remote control, move these appliances or consult with your local dealer.

**Location of the remote control**

- Keep the remote control where its signals can reach the receiver of the indoor unit (a distance of up to 7 m is allowed).
- When you select timer operation, the remote control automatically transmits a signal to the indoor unit at the specified time.  
If you keep the remote control in a location where proper signal transmission is blocked, a time lag of up to 15 minutes may occur.

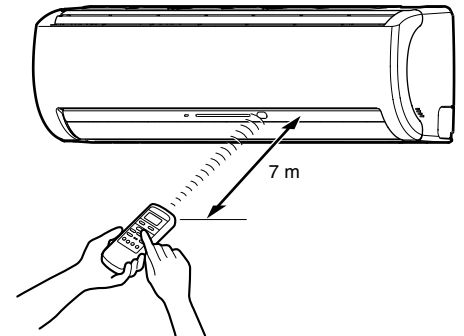

**Remote control holder**

**Installing the remote control holder**

- Before you actually install the remote control holder on a wall or pillar, check whether the remote control signals can be received by the indoor unit.

**Mounting and removing the remote control**

- To mount the remote control, hold it parallel to the remote control holder and push it in fully. To remove the remote control, slide the remote control upwards and out from the holder.

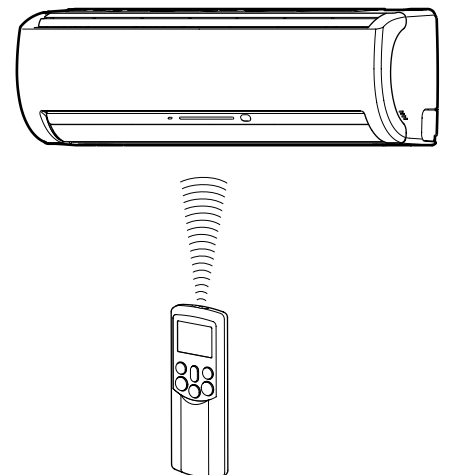
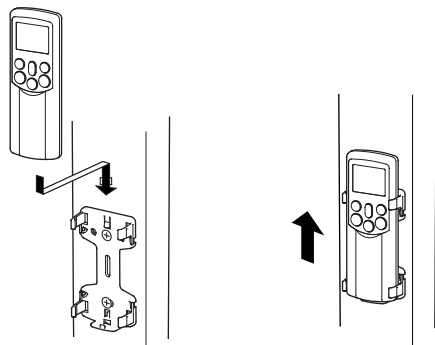

# AUTOMATIC OPERATION

When you set the air conditioner to AUTO mode, it automatically selects cooling, heating (heat pump models only), or fan only operation depending on the room temperature. (☞ see page 16.)  
The fan speed and louver are also automatically controlled.

## Start

- ① **Power button**  
Press this button to start the air conditioner.
- ② **AUTO button (AUTO)**  
Press AUTO button.
- ③ **Temperature button (TEMP)**  
Set the desired temperature.

- The OPERATION indicator (green) on the display panel of the indoor unit lights. The operating mode is selected according to the room temperature and operation starts after approximately 3 minutes.
- If the AUTO mode is uncomfortable, you can select the desired conditions manually. The temperature, fan speed and louver position can be changed, and MODE is also changed from AUTO to A when the fan speed or louver position is changed. The fan speed indicator is also shown.

## Stop

- Power button**  
Press this button again to stop the air conditioner.

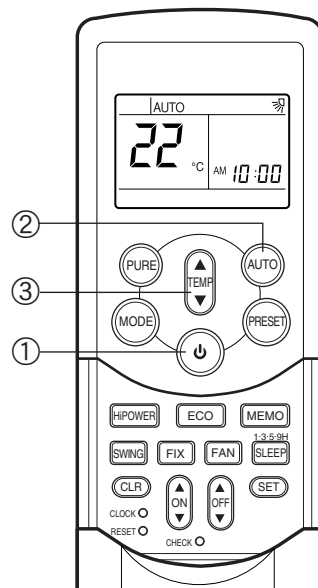

# AUTOMATIC OPERATION (AUTO CHANGEOVER)

When you set the air conditioner to A mode or switch over from AUTO operation because of a change in settings, the air conditioner automatically selects cooling, heating (heat pump models only), or fan only operation depending on the room temperature. (☞ see page 16.)

## Start

- ① **Power button**  
Press this button to start the air conditioner.
- ② **Mode select button (MODE)**  
Select A.
- ③ **Temperature button (TEMP)**  
Set the desired temperature.
- ④ **Fan speed button (FAN)**  
Select one of "AUTO" LOW , LOW+ , MED , MED+ , HIGH .

- The OPERATION indicator (green) on the display panel of the indoor unit lights. The operating mode is selected according to the room temperature and operation starts after approximately 3 minutes.
- The temperature, fan speed and louver position can be changed. You can select the desired conditions manually.

## Stop

- Power button**  
Press this button again to stop the air conditioner.

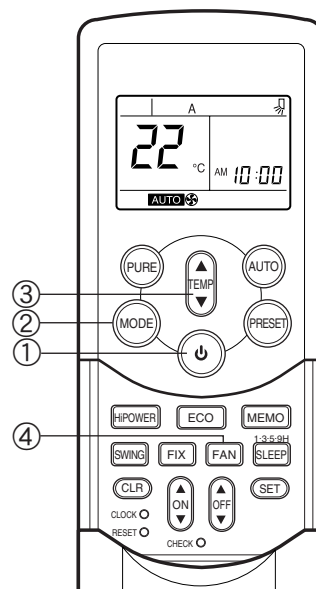

# COOLING/HEATING OPERATION

## Start

### ① button

Press this button to start the air conditioner.







### ② **Mode select button (MODE)**

Select COOL  or HEAT  (heat pump models only).

### ③ **Temperature button (TEMP)**

Set the desired temperature.

### ④ **Fan speed button (FAN)**

Select one of "AUTO" , LOW , LOW+ , MED , MED+ , HIGH .

- The OPERATION indicator (green) on the display panel of the indoor unit turns on. Operation starts after approximately 3 minutes.

## Stop

### button

Press this button again to stop the air conditioner.

- Heating operations cannot be performed by a cooling-only model.

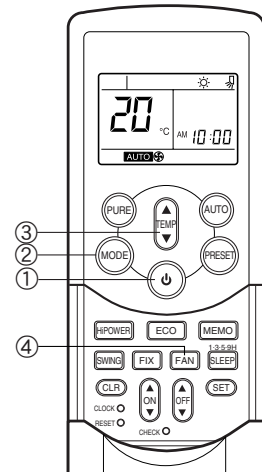

# DRY OPERATION

## Start

### ① button

Press this button to start the air conditioner.

### ② **Mode select button (MODE)**

Select DRY .

### ③ **Temperature button (TEMP)**

Set the desired temperature.

- The fan speed setting is fixed to AUTO and the AUTO is displayed.
- The OPERATION indicator (green) on the display panel of the indoor unit turns on, and operation starts after approximately 3 minutes.

## Stop

### button

Press this button again to stop the air conditioner.

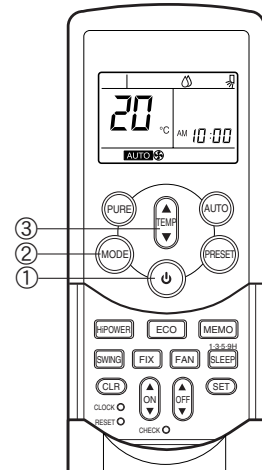

# FAN ONLY OPERATION (cooling-only models only)

## Start







### ① button

Press this button to start the air conditioner.

### ② **Mode select button (MODE)**

FAN ONLY .

### ③ **Fan speed button (FAN)**

Select one of "AUTO" , LOW , LOW+ , MED , MED+ , HIGH .

- The OPERATION indicator (green) on the display panel of the indoor unit turns on. Operation will start immediately.
- The : FAN ONLY mode does not control the temperature.

## Stop

### button

Press this button again to stop the air conditioner.

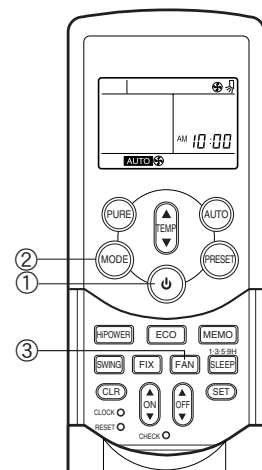

# PURE OPERATION

Press this button to start the electrical air purifying operation.

## During air conditioner operation

### ① PURE button

Pressing this button starts PURE operation.

- The PURE indicator (blue) on the display panel of the indoor unit turns on.
- Plasma pure filter and air ionizer are activated.

## To stop only PURE operation

### PURE button

Pressing this button stops PURE operation.

- The PURE indicator (blue) on the display panel of the indoor unit turns off.
- Plasma pure filter and air ionizer are deactivated.

## To stop air conditioner operation at the same time

### ⏻ button

Pressing this button stops air conditioner operation and PURE operation.

- The OPERATION indicator (green) and PURE indicator (blue) on the display panel of the indoor unit turn off.

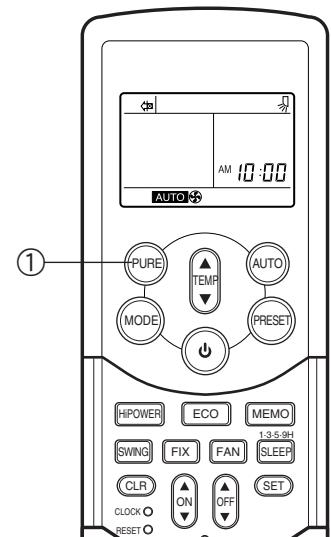

## CAUTION

- When the ⏻ button is pressed the next time, operation starts with the combined air conditioner and PURE operation.
- During the combined air conditioner and PURE operation, air conditioner operation only cannot be stopped.

## When the air conditioner is stopped

### ① PURE button

Pressing this button starts PURE operation.

- The PURE indicator (blue) on the display panel of the indoor unit turns on.

## INFORMATION

- The air ionizer starts in conjunction with air purifying operation.
- During the air purifying operation, a small amount of ozone is produced, and you might notice the smell.
- When the air flow is automatic, it changes between LOW  $\leftarrow$  and MED+  $\leftarrow\leftarrow\leftarrow\leftarrow\leftarrow$ .  
LOW  $\leftarrow$  operation is performed when the indoor air becomes clean. During operation, the position of the vertical air flow louvers may change if the room temperature is low.
- Opening the front panel during PURE operation sometimes turns on the FILTER indicator (orange).  
In this case, stop PURE operation (stop the air conditioner if it is also operating), and then close the front panel.
- The FILTER indicator (orange) turns on after PURE operation is performed for about 1000 hours.  
When the indicator turns on, clean the plasma pure filter. (see page 21.)

# Hi POWER OPERATION

## High power (Hi POWER)

- The Hi POWER (high power operation) mode automatically controls room temperature, air flow and the operation mode so that the room is quickly cooled in summer and warmed in winter. (☞ see page 16.)

## Setting Hi POWER mode

### ① Hi POWER button

Press the Hi POWER button. The Hi POWER mark on the remote control is shown.

## Canceling Hi POWER mode

### ① Hi POWER button

Press the Hi POWER button once again.

The Hi POWER mark on the remote control turns off.

### CAUTION

The Hi POWER mode cannot be activated during DRY operation and FAN ONLY operation (cooling-only models only).

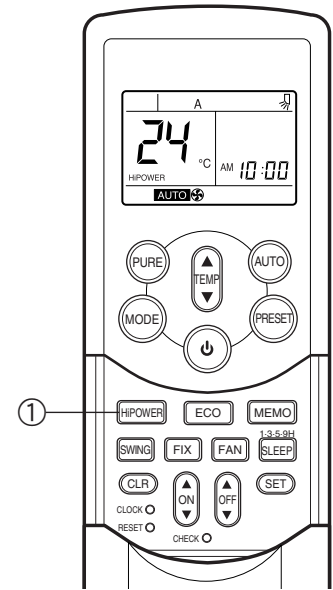

# TIMER OPERATION

## ON timer and OFF timer

### Setting the ON Timer

#### ① ON button

Press the ON  button. Set the timer to the desired time.

Each time the ON button is pressed, the time changes in ten minute increments. Holding down the ON button changes the time in one hour increments.

#### ② SET button

Press the SET  button to set the timer.

The timer time is displayed, and the timer starts.

#### ③ CLR button

Press the CLR  button to cancel the timer setting.

### Setting OFF Timer

#### ① OFF button

Press the OFF  button.

Set the timer to the desired time.

Each time the OFF button is pressed, the time changes in ten minute increments. Holding down the OFF button changes the time in one hour increments.

#### ② SET button

Press the SET  button to set the timer.

The timer time is displayed, and the timer starts.

#### ③ CLR button

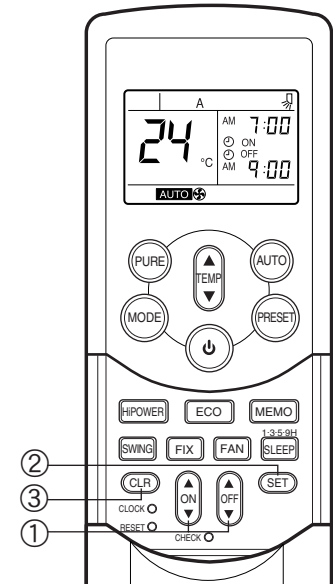

Press the CLR  button to cancel the timer setting.



### CAUTION

- When you select timer operation, the remote control automatically transmits the timer signal to the indoor unit at the specified time. Therefore, keep the remote control in a location where it can transmit the signal to the indoor unit properly.
- If you do not press the SET  button within 30 seconds after setting the time, the setting will be cancelled.

Once you select timer operation mode, the settings are saved in the remote control.

Thereafter, the air conditioner will start operating under the same conditions as if you pressed the  or  button of the remote control.

You cannot set the timer when the clock display is flashing.

Follow the instructions in the section "Setting the clock" on page 6 to set the clock, and then set the timer.

## Combined timer (Setting the ON and OFF timers simultaneously)

### OFF timer → ON timer



#### (Operation → Stop → Operation)

This feature is useful when you want to stop the air conditioner after you go to sleep, and start it again in the morning when you wake up or you return home.

Example:

To stop the air conditioner and start it again next morning

#### Setting combined TIMER

- (1) Press the OFF  button to set the OFF timer.
- (2) Press the ON  button to set the ON timer.
- (3) Press the SET  button.

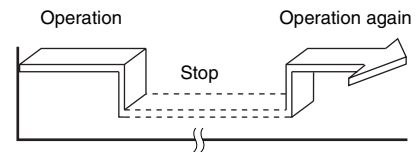

### ON timer → OFF timer



#### (Stop → Operation → Stop)

You can use this setting to start the air conditioner when you wake up and stop it when you leave the house.

Example:

To start the air conditioner the next morning and stop it

#### Setting combined TIMER

- (1) Press the ON  button to set the ON timer.
- (2) Press the OFF  button to set the OFF timer.
- (3) Press the SET  button.

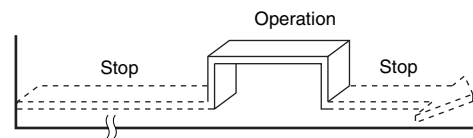

- The ON or OFF timer function that is closer to the current time is activated first.
- If the same time is set for both ON and OFF timers, no timer operation is performed. Also, the air conditioner may stop operating.





### CAUTION

Approximately 3 seconds later, the remote control will transmit the signal to the indoor unit and a receiving beep will sound from the indoor unit after you press the SET  button.

## Daily combined timer (setting the ON and OFF timers simultaneously and activating every day.)

This feature is useful when you want to use the combined timers at the same time every day.

#### Setting combined TIMER

- (1) Press the ON  button to set the ON timer.
- (2) Press the OFF  button to set the OFF timer.
- (3) Press the SET  button.
- (4) After step (3), an arrow mark (↑ or ↓) flashes for about 3 seconds. Press the SET  button during this flashing.

- Both arrows (↑, ↓) are shown while the daily timer is activated.

#### Cancelling timer operation

Press the CLR  button.

#### Clock display

During TIMER operation (ON-OFF, OFF-ON, OFF timer), the clock time indicator is not shown so the setting time can be displayed. To view the current time, press the SET  button briefly and the current time will be displayed for about 3 seconds.

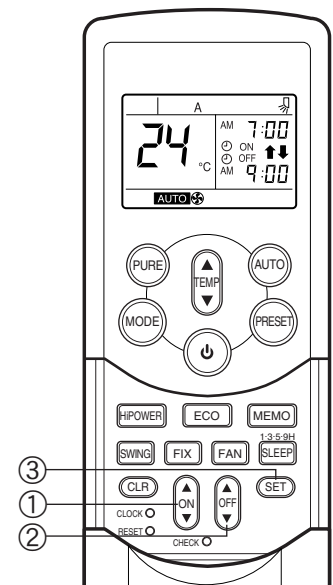

# MEMORY/PRESET OPERATION

Use the MEMO button to store a frequently used operation setting for convenience. Start the air conditioner in the operation mode that you want the remote control to store. Press the button as shown below while the air conditioner is operating.

## ① MEMO button

Press this button briefly to ready for storing the setting.

All the icons currently shown flash, except for the clock time indicator and mode indicator.

## ② MEMO button

Hold down the MEMO button for more than 3 seconds while the indicator flashes.

The **P** mark is shown and the setting is stored.

- If you do not press the MEMO button within 3 seconds or if you press another button, the MEMORY setting is cancelled.
- Operation modes which can be stored with the MEMO button are MODE, Temperature, FAN, TIMER and Hi POWER.

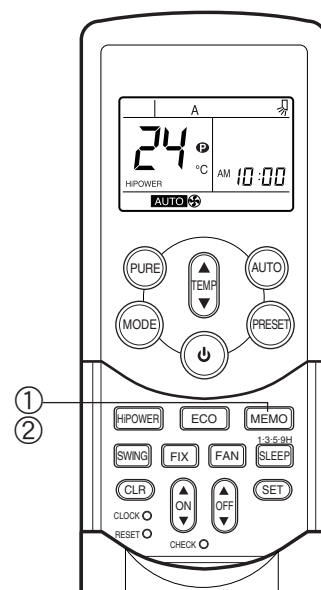

To operate the air conditioner with the setting stored using the MEMO button.

## ① PRESET button

Press the PRESET button. The setting stored with the MEMO button will be shown and the air conditioner operates based on the setting.

### (A): When the PRESET button is pressed while operation is stopped

- The OPERATION indicator (green) on the display panel of the indoor unit turns on, and operation starts after approximately 3 minutes.

### (B): When the PRESET button is pressed during operation

- The operation mode changes to the setting stored with the MEMO button.

- Initial setting:

MODE : AUTO

Temperature : 22

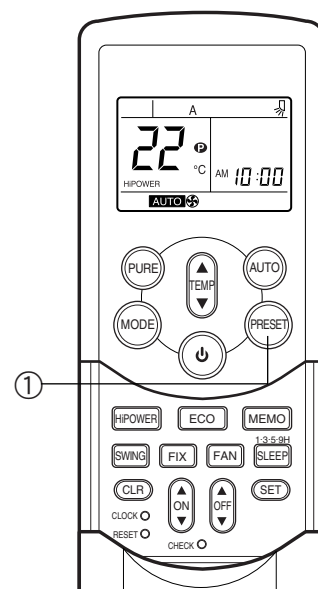

# ADJUSTING AIR FLOW DIRECTION

- Adjust the air flow direction properly. Failure to do so could cause discomfort and make an uneven room temperature distribution.
- Adjust the vertical air flow using the remote control.
- Adjust the horizontal air flow manually.

## Adjusting the vertical air flow

The air conditioner automatically adjusts the vertical air flow direction according to the operating conditions when AUTO or A mode is selected.

### To set a selected air flow direction

Use this function when the air conditioner is operating.

#### ① FIX button

Hold down or briefly press the FIX button on the remote control to move the louver in the desired direction.

- Change the vertical air flow louver direction within the range indicated.
- In subsequent operations, the vertical air flow is automatically set to the direction that you set the louver using the FIX button.

### To automatically swing the air flow direction

Perform this function when the air conditioner is operating.

#### ① SWING button

Press the SWING button on the remote control.

- To stop the function, press the SWING button.
- To change the swing direction, press the FIX button.

## CAUTION

- The FIX and SWING buttons will be disabled when the air conditioner is not operating (including when ON TIMER is set).
- Do not operate the air conditioner for an extended period of time with the air flow direction set downward during the cooling or dry operation. Otherwise, condensation may occur on the surface of the vertical air flow louver and cause water dripping.
- Do not move the vertical air flow louver manually. Always use the FIX button. If you move the louver manually, it may malfunction during operation. If the louver malfunctions, stop the air conditioner once, and restart.
- When the air conditioner is started immediately after it was stopped, the vertical air flow louver might not move for about 10 seconds.

## Adjusting the horizontal air flow

### Preparation:

- Grasp the lever on the horizontal air flow louver and move them to adjust the air flow direction as required.
- You can adjust the air flow at the left and right locations of the grilles.

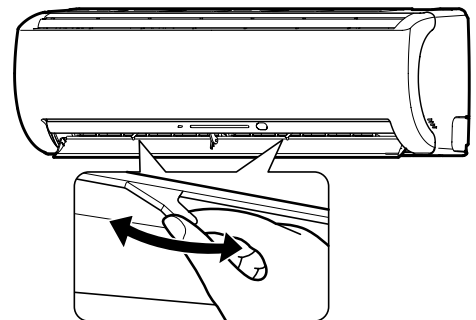
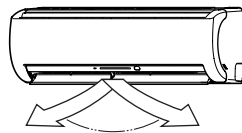
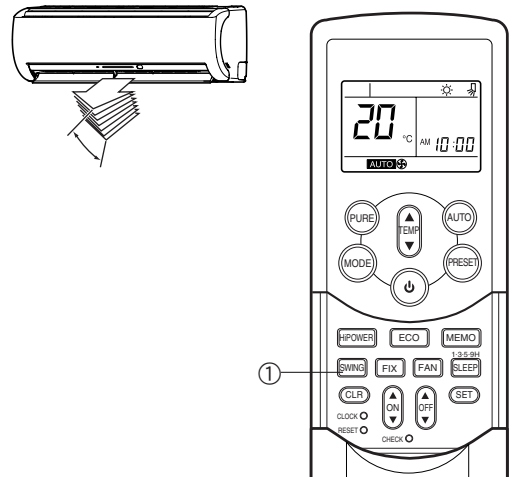
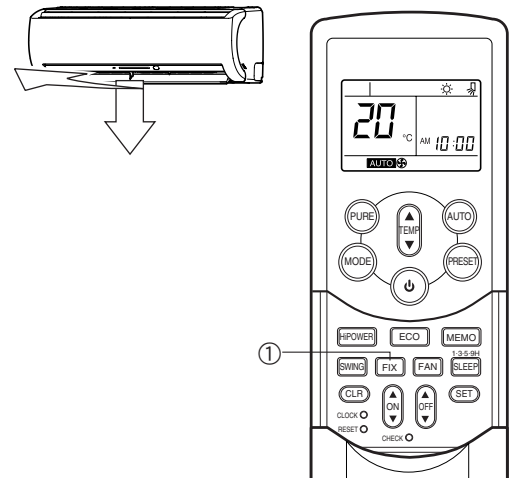

# AUTO RESTART OPERATION

This air conditioner is equipped with an automatic restarting function which allows the air conditioner to resume without the use of the remote control under the operating settings in the event of a power shutdown. Operation resumes without warning three minutes after power is restored.

## INFORMATION

The AUTO RESTART OPERATION is not set to work at factory shipment, and so it is necessary to set it to this function if required.

## HOW TO SET AUTO RESTART

To set the auto restart function, proceed as follows:

The power supply to the unit must be on. The function will not be set if the power is off.

To enable the auto restart function, hold down the RESET button for 3 seconds.

The air conditioner receives the setting and beeps 3 times. The system now restarts automatically. The auto restart setting is activated.

(1) When the air conditioner is in stand-by (not running).

Hold down the RESET button for more than 3 seconds.

- The air conditioner starts to operate. The green indicator turns on.
- After about 3 seconds, the air conditioner beeps 3 times.

**The green indicator flashes for 5 seconds.**

- The air conditioner is operating.

If the air conditioner is not required to run at this time, push the RESET button again or use the remote control to stop the air conditioner.

(2) When the air conditioner is operating.

Hold down the RESET button for more than 3 seconds.

- The air conditioner stops operating. The green indicator turns off.
- 3 seconds after pushing the button, the air conditioner beeps 3 times.

**The green indicator flashes for 5 seconds**

- The air conditioner stops.

If you do not need the air conditioner to stop at this time, use the remote control to restart the air conditioner. During the subsequent operation, the green indicator is turned on.

- The auto restart operation will not accept a command if timer operation with the remote control is activated.
- After restarting the air conditioner by the AUTO RESTART OPERATION, the louver swing (AUTO) operation does not resume.

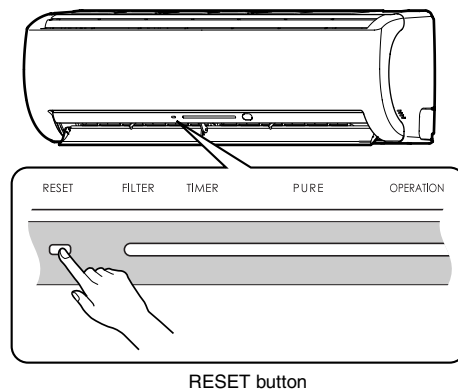

## HOW TO CANCEL AUTO RESTART

To cancel the auto restart operation, proceed as follows:

Repeat the setting procedure. The air conditioner receives the setting and beeps 3 times.

The air conditioner now needs to be manually restarted with the remote control after the main supply is turned off.

The auto restart setting is cancelled.

(1) When the air conditioner is in stand-by (not running).

Hold down the RESET button for more than 3 seconds.

- The air conditioner starts to operate.  
The green indicator will turn on.
- After about 3 seconds, the air conditioner beeps 3 times.
- The air conditioner is operating.

If the air conditioner is not required to run at this time, push the RESET button again or use remote control to stop the air conditioner.

(2) When the air conditioner is operating.

Hold down the RESET button for more than 3 seconds.

- The air conditioner stops operating.  
The green indicator is turned off.
- After about 3 seconds, the air conditioner beeps 3 times.
- The air conditioner stops.

If you do not need the air conditioner to stop at this time, use the remote control to restart the air conditioner.

During subsequent operation, the green indicator is turned on.

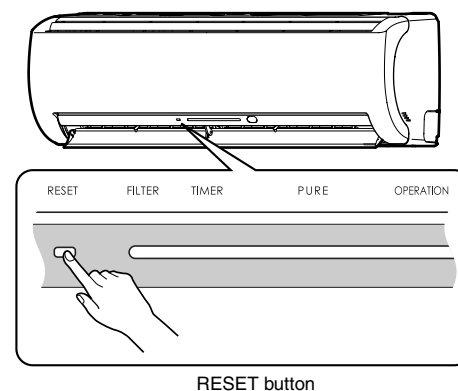

# HOW THE AIR CONDITIONER WORKS

## Automatic Operation

As shown in Figures 1 and 2, Automatic Operation mode selects the operation based on the room temperature data ( $T_a$ ) when operation begins.

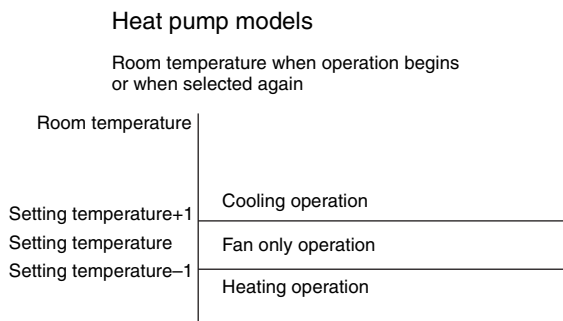

Figure 1

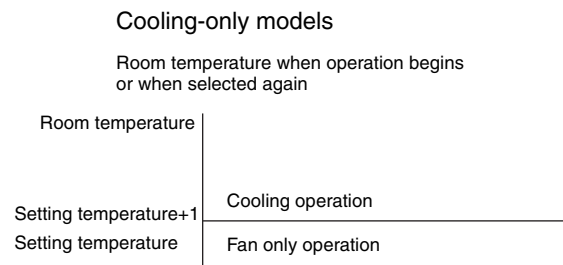

Figure 2

The operation mode is selected again after the compressor has remained stopped for 15 minutes.

## Hi POWER operation

When you press the Hi POWER button during cooling, heating or A operation, the air conditioner starts the following operation.

### • Cooling operation

The cooling operation is performed at 1°C lower than the temperature setting.

When the room temperature is higher than the temperature setting, the air flow is directed downward. The fan speed is also set to high\*. Once the room temperature is within 1°C of the temperature setting, the air flow is returned to its previous direction.

\* The noise level raises, according to the fan speed.

### • Heating operation (heat pump models)

The heating operation is performed at 2°C higher than the temperature setting.

The air flow direction and fan speed are automatically switched according to the operating condition.

## ECO operation

When you press the ECO button during cooling, heating or A operation, the air conditioner starts the following operation.

The fan speed is controlled automatically.

### • Cooling operation (❄)

In the minimum operation zone, where the air conditioner is operated at minimum capacity, overcooling is prevented by raising the temperature setting.

The room temperature is thus regulated between the minimum operation zone and the temperature setting.

### • Heating operation (☀) (heat pump models)

In the minimum operation zone, where the air conditioner is operated at minimum capacity, overheating is prevented by lowering the temperature setting.

The room temperature is thus regulated between the temperature setting and the minimum operation zone.

**Dry operation (☽)**

The dry mode automatically selects the cooling dry operation based on the difference between the temperature setting and the actual room temperature.  
The fan speed indicator shows AUTO, and low speed is used.

**HINTS FOR ECONOMICAL OPERATION**

**Maintain room temperature at a comfortable level**

**Clean the air filters**

Clogged air filters impair the performance of the air conditioner. Clean them once every two weeks.

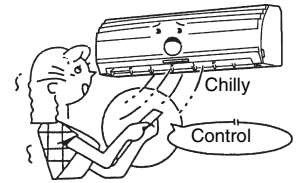
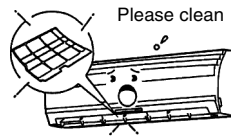

**Never open doors and windows more than is necessary**

To keep cool or warm air in the room, never open doors and windows more than is necessary.

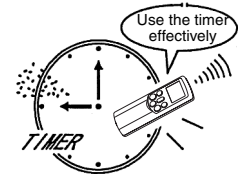
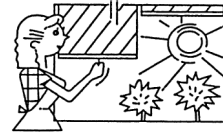

**Window curtains**

During cooling operation, close the curtains to avoid direct sunlight. During heating operation, close the curtains to keep the heat in.

**Use the timer effectively**

Set the timer for the desired operating time.

**Allow uniform circulation of room air**

Adjust the air flow direction for even circulation of room air.

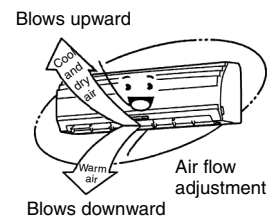
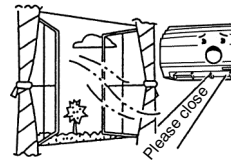

**TEMPORARY OPERATION**

**Temporary operation**

This function is used to operate the unit temporarily in case you misplace the remote control or the batteries are used up.

- Push the RESET button to start the automatic operation (AUTO).
- While the temporary operation is activated, the remote control operation is disabled.
- Hold down the button for 10 seconds to start the cooling operation.

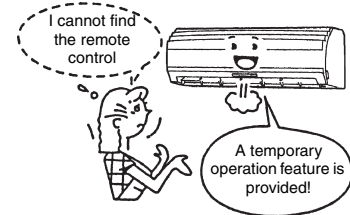

**CLEANING OPERATION**

**Cleaning operation**

This function is used to dry the inside of the air conditioner to reduce the growth of mold, etc. inside the air conditioner.

- When the unit shuts down after having operated for 10 or more minutes in the cooling or dry mode, the cleaning operation is started automatically, and the S.CLEAN indicator on the unit's display panel turns on.

**Cleaning operation duration**

- The cleaning operation lasts for 2 hours if the unit has been operating in the cooling or dry mode for less than one hour.
- The cleaning operation lasts for 4 hours if the unit has been operating in the cooling or dry mode for one hour or more.

**About the cleaning operation**

- The cleaning operation will not make the room cleaner or remove the mold and dust already inside the air conditioner.
- During operation, a small amount of frost may be visible: this is normal and does not indicate a malfunction.
- The vertical airflow louvers open slightly.
- If an ongoing cleaning operation is suspended, the effect of the cleaning will be compromised.
- To forcibly stop the cleaning operation, press the ⏻ button twice during the cleaning operation.

# USUAL MAINTENANCE

## WARNING

Before you clean the air conditioner, be sure to turn off the circuit breaker or main power switch.

## Cleaning of indoor unit and remote control

### CAUTION

- Use a dry cloth to wipe the indoor unit and remote control.
- When the air conditioner is extremely dirty, use a cloth dipped in cold water to wipe the indoor unit.
- Never use a damp cloth on the remote control.
- Do not use a chemical-based duster for wiping or leave such materials on the unit for extended periods of time. Doing so could damage or cause the surface of the unit to fade.
- Do not use benzine, thinner, polishing powder, or other solvents for cleaning. These can cause the plastic surface to crack or deform.

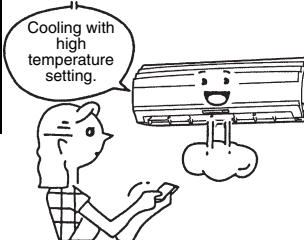
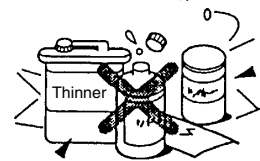

## When not using the unit for at least 1 month

- (1) Perform fan operation for three to four hours to dry the inside of the unit.
  - If a high temperature setting is used with cooling operation, fan operation is performed.
- (2) Stop the air conditioner and turn off the circuit breaker.
- (3) Clean the air filters.
- (4) Remove the batteries from the remote control.

## Check before operation

### CAUTION

- Check that the air filters are installed.
- Check that the air outlet and inlet of the outdoor unit are not blocked.

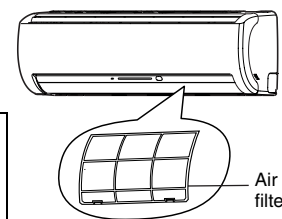

## Cleaning the air filter

Clean the air filters every 2 weeks.

The performance of the air conditioner will degrade if the air filters are covered with dust.

Clean the air filters as often as possible.

### Preparation:

1. Turn off the air conditioner using the remote control.
2. Open the air inlet grille.

- 1** Open the air inlet grille.  
Lift the air inlet grille up to the horizontal position.
- 2** Grasp the left and right handles of the air filter and lift it up slightly, and then pull it downward to take it out from the filter holder.
- 3** Use a vacuum cleaner to remove the dust from the filters or wash them with water. After washing the air filters, dry them in the shade.

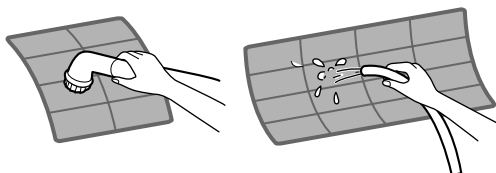
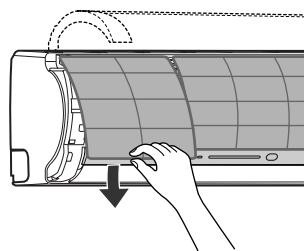
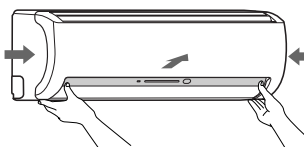

- 4 Insert the top section of the air filter so that its right and left edges fit on the indoor unit and it is firmly set.
- 5 Close the air inlet grille.
  - \* If the FILTER indicator on the indoor unit is shown, press the RESET button on the indoor unit to turn off the indicator.

**Cleaning the air inlet grille**

**Preparation:**

1. Turn off the air conditioner using the remote control.
2. Open the air inlet grille.

- 1 Remove the air inlet grille.  
Hold the two sides of the air inlet grille and open upwards.  
Remove the left (or right) arm by pushing it toward the outside and then pulling it toward you.
- 2 Wash it with water using a soft sponge or towel.  
(Do not use a metallic scrubbing brush or other hard brushes.)
  - Use of such hard objects will cause scratches on the surface of the grille and the metal coating to peel off.
  - If extremely dirty, clean the air inlet grille with a neutral kitchen detergent and rinse it off with water.
- 3 Wipe off the water from the air inlet grille and dry it.
- 4 Fit the left and right arms of the air inlet grille to the shafts on the two sides of the air conditioner and push them in completely.
- 5 Pull the air inlet grille downward.
  - Push the arrow locations (four) at the bottom of the air inlet grille to check that the grille is completely closed.

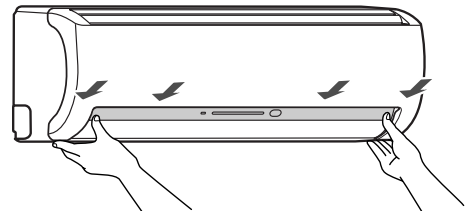
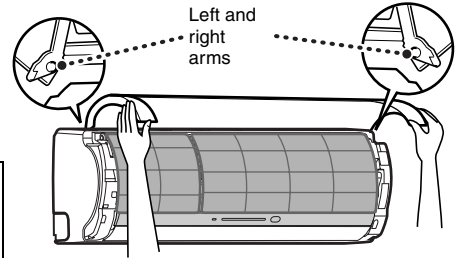
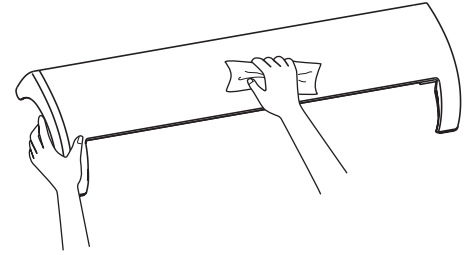
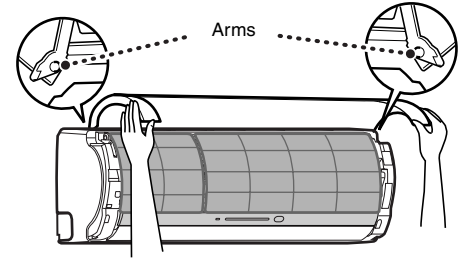
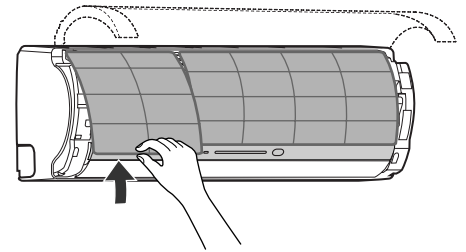

**NOTE**

Cleaning and maintenance of the indoor/outdoor units are strongly recommended for air conditioning systems which are used regularly. Failure to clean the indoor/outdoor units regularly will result in poor cooling performance, icing, water leakage and even premature compressor failure.

# SPECIAL MAINTENANCE

## Attaching the Zeolite-plus filter

- After installing the air conditioner, attach the supplied Zeolite-plus filter.

### Preparation:

1. Turn off the air conditioner using the remote control.

## Cleaning the Zeolite-plus filter

- Clean the filter when you clean the plasma pure filter. (Clean approximately once every six months.)

### Preparation:

1. Turn off the air conditioner using the remote control.

- 1** Open the air inlet grille.  
Lift up the air inlet grille until it clicks into place.
- 2** Take off the air filter from the left side.  
Grasp the left and right handles of the air filter and lift up slightly and then pull downward to remove the filter from the filter holder.
- 3** Remove the Zeolite-plus filter from the front panel.
- 4** Wash the Zeolite-plus filter in water, and then drain.
  - If the filter is dirty with dust and dirt, use a vacuum cleaner to remove the dirt before washing with water. Also, be sure to always use clean water when washing. If dirty water is used, the debris in the water can adhere to the filter.
  - Do not rub the filter surface.
  - In the final of the water washing, be sure to always rinse the filter with clean water.
  - If the filter is particularly dirty, add a neutral detergent at the standard concentration and then rinse with clean water until there are no more soap bubbles.
  - Drain gently after washing with water.
- 5** Allow the Zeolite-plus filter to dry in the sun.
  - It takes about six hours for the filter to dry in direct sunlight.
- 6** Attach the Zeolite-plus filter and the air filter, then close the air inlet grille.

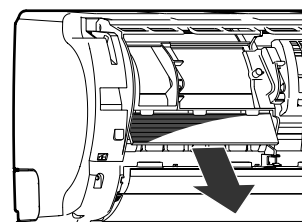
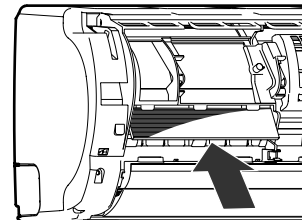

## INFORMATION

- It is recommended that you replace the filter once about every six years. Deodorizing performance will drop when there are severe stains due to extended periods of usage such as due to tar accumulation from cigarette smoke.

### Items sold separately

Zeolite-plus filter (RB-A612DE)

### Cleaning the air ionizer

- Clean the air ionizer when you clean the plasma pure filter. (Clean approximately once every six months.)

#### Preparation:

1. Turn off the power supply.

#### WARNING

Touching the ends of the metal pins inside the air ionizer (dark blue) can result in an electrical shock.

- 1 Fully open the vertical air flow louvers by hand.
- 2 Remove the dust on the air ionizer.
  - Use a toothbrush to rub the ends of the metal pins inside the air ionizer (dark blue) three or four times.
  - Do not use cotton swabs or other objects with fluff.
- 3 Close the vertical air flow louvers.

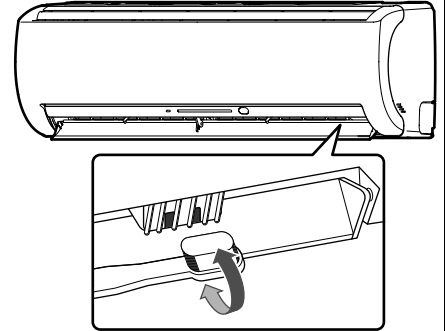

### Cleaning the plasma pure filter

- Clean the plasma pure filter when the FILTER indicator (orange) turns on. (This indicator turns on after PURE operation of about 1000 hours.)
- After cleaning is finished, push the RESET button on the indoor unit.
- Perform cleaning about once every six months.
- Even if the FILTER indicator does not turn on, clean the plasma pure filter whenever the unit makes a humming, clicking, or buzzing sound. If the indicator turns on during the night, the air conditioner can still be used until the morning without a problem, but be sure to perform cleaning as soon as possible.

#### Preparation:

1. Turn off the power supply.

- 1 Open the air inlet grille.
  - Lift up the air inlet grille until it clicks into place.
- 2 Grasp the left and right handles of the air filter and lift up slightly and then pull downward to remove the filter from the filter holder.
- 3 Take out the plasma pure filter.
  - Grasp the handles, and then pull out as shown in ① and ②.

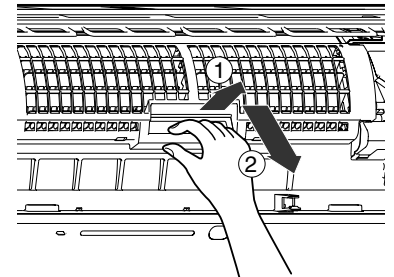

### Checks after cleaning the plasma pure filter

1. Confirm the FILTER indicator does not turn on by activating PURE operation for one hour or more.
  - <If it does not turn on, it is normal>
2. If the FILTER indicator turns on, recheck the following.
  - a) Fitting of the plasma pure filter
  - b) Fitting of the air inlet grille
 And, reconfirm the FILTER indicator does not turn on by activating PURE operation for another one hour or more.
  - <If it does not turn on, it is normal>
3. In case the FILTER indicator does turn on, please call a service representative.

#### 4 Wash and then dry.

- (1) Soak in hot water at 40 to 50°C for about 10 to 15 minutes. If the staining is particularly severe, use a washing detergent compound (weak basic or neutral) at 10 to 15 times the standard concentration.
- (2) Rub up and down, and rub left and right. Also, rub the surface gently with a sponge.
- (3) Rinse with running water.
- (4) Shake thoroughly, and allow the unit to drain.  
(If oil or smoke strains are particularly hard to remove, repeat steps (1) to (4) two or three times.)
- (5) Dry thoroughly in the shade.

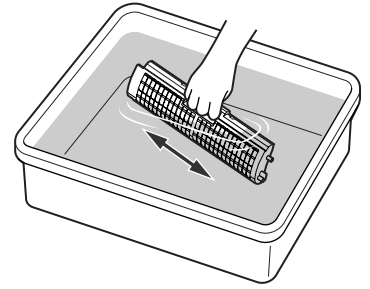

#### CAUTION

- Never use any products marked as “bleach”.
- Do not attempt to disassemble the unit.
- Do not rub with a scrubbing brush or similar implement.
- Do not utilize washing devices or equipment.
- Do not dry with a hair dryer or other appliance that uses hot air. (The heat can cause the unit to deform.)
- After cleaning, wait until the unit is completely dried before attaching. The FILTER indicator may turn on if the unit is used while wet.

#### 5 Attach the plasma pure filter.

- Grasp the handles, and then insert as shown in ①. Insert into the right and left guide rails, and then press in the direction of ② after it is all the way in.
- Press both ends of the plasma pure filter in the direction of ③ until the protrusions on both sides of the plasma pure filter are completely inserted into the holders.

Press in the plasma pure filter until the protrusions on both sides are completely inserted into the holders. If installation is incomplete, the FILTER indicator (orange) may light.

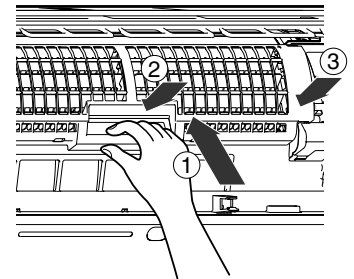

#### 6 Attach the air filter, and then close the air inlet grille.

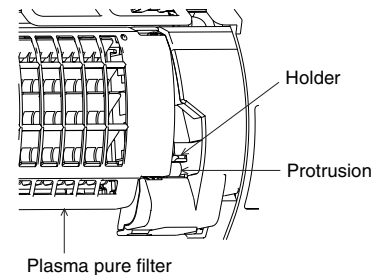

# AIR CONDITIONER OPERATION AND PERFORMANCE

## Three-minute protection feature

A protection feature is provided that prevents the air conditioner from being activated for approximately 3 minutes when it is restarted immediately after operation or when the power supply switch is set to on. This is used to protect the machine.

## Heating characteristics (heat pump models)

### Preheating operation

The air conditioner does not deliver warm air immediately after it is started.

Warm air flows out after approximately 5 minutes when the indoor heat exchanger has warmed up.

### Warm air control

When the room temperature reaches the temperature setting, the fan indoor speed is automatically reduced.

The outdoor unit is stopped at this time.

### Defrosting

If frost has formed on the outdoor unit during the heating operation, defrosting is started automatically (for approximately 5 to 10 minutes) to maintain the heating effect.

- The fans in both the indoor and outdoor units stop during the defrost operation.
- During the defrost operation, defrosted water is drained from the bottom plate of the outdoor unit.

### Heating capacity



In the heating operation, heat is absorbed from outdoors and released into the room. That is called the heat pump system. When the outdoor temperature is too low, usage of another heating apparatus in combination with the air conditioner is recommended.

### Consideration for accumulated snow

Select the position for the outdoor unit where it will not be subjected to snow drifts, accumulation of leaves or other seasonal debris. It is important that the air flow of the outdoor unit is not blocked as this will result in reduced heating or cooling performance. During the heating mode and at sub-zero temperatures, the water drained off the outdoor unit as a result of the automatic defrost may accumulate and freeze. It is important that adequate drainage or a soak-way be provided.

### Power failure

Power failure during operation stops the unit completely.

- The OPERATION indicator (green) on the indoor unit starts flashing when power is restored.
- To restart operation, push the  button on the remote control.
- Lightning or a car wireless telephone operating nearby may cause the unit to malfunction. Turn the power supply switch off and then on again. Push the  button on the remote control to restart.

### Air conditioner operating conditions

For proper performance, operate the air conditioner under the following temperature conditions.

Cooling operation	Outdoor temperature: 5°C to 43°C
	Room temperature: 21°C to 32°C
	<b>CAUTION</b> Room relative humidity — less than 80%. If the air conditioner operates outside this range, the surface of the air conditioner may attract condensation.
Heating operation (heat pump models)	Outdoor temperature: -15°C to 24°C
	Room temperature: Less than 28°C
Dry operation	Outdoor temperature: 10°C to 43°C
	Room temperature: 17°C to 32°C

If the air conditioner is used in conditions other than above, the safety protection functions may be activated.

# TROUBLESHOOTING

## CAUTION

If any of the following conditions occur, stop the air conditioner immediately, turn off the main power switch and contact the dealer.

- The indicators flash at short intervals (5 Hz). Reset the circuit breaker 2 to 3 minutes after the power main switch is turned off. Despite the resetting operation, the indicators still continue turning on and off.
- Switch operation is erratic.
- The main power fuse often blows, or the circuit breaker is often activated.
- Foreign matter or water has fallen inside the air conditioner.
- Any other unusual conditions are observed.

Before asking for servicing or repairs, check the following points.

### Inoperative

- The power main switch is turned off.
- The circuit breaker is activated to cut off the power supply.
- The main power fuse has blown.
- The electric current has stopped.
- The batteries in the remote control used up.
- The ON timer is set.
- As a protective mechanism for the air conditioner, it does not operate for three minutes immediately after restarting operation or turning on the main power.



### Poor cooling or heating performance

- The air inlet or outlet of the outdoor unit is blocked.
- Doors or windows are opened.
- The air filter is clogged with dust.
- The louver is not at the correct position.
- The fan speed is set to low.
- The air conditioner is set to the DRY or ECO mode.
- The temperature setting is too high (during cooling operation).
- The temperature setting is too low (during heating operation). (heat pump models)



Recheck

Before asking for servicing or repairs, check the following points.

**Condensation forms on the back of the indoor unit.**

- Condensation on the back of the indoor unit is automatically collected and drained out.

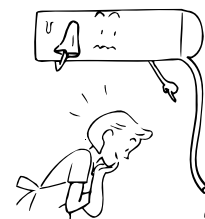

**Indoor unit or outdoor unit makes a strange noise.**

- When the temperature changes sharply, the indoor or outdoor unit may make a strange noise (such as a tit-tack noise or flowing noise) because of the expansion/contraction of parts or change in refrigerant flow.

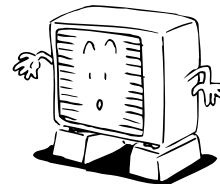

**The room air is smelly.**

**A bad odor comes from the air conditioner.**

- Smells absorbed in the wall, carpet, furniture, clothing, or furs are coming out.
- During PURE operation, a small amount of ozone is produced, and you might notice the smell.

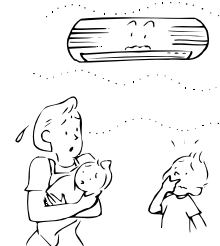

**The OPERATION indicator turns on and off.**

- The indicator turns on and off (1 Hz) when power is restored after a power failure or when the power main switch is set to on. Reset the circuit breaker to ON.

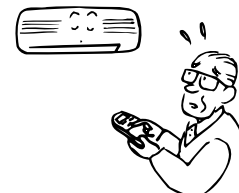

**Frost forms on the outdoor unit during heating operation. (heat pump models)**

**Water is drained from the outdoor unit.**

- Frost sometimes forms on the outdoor unit during heating operation. In that case, the unit automatically performs defrosting (for 2 to 10 minutes) for improving the heating efficiency.
- In the defrosting operation, the airflow from both the indoor and outdoor units stops.
- A hiss sound is heard when the flow of the refrigerant is changed for defrosting.
- The water resulting from automatic defrosting during the heating operation is drained from the outdoor unit.

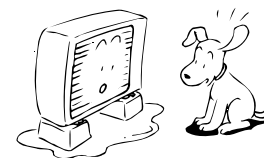

**The air flow changes even though the FAN button is not set to the AUTO mode.**

- When the temperature of the blown air goes down during heating operation, the air conditioner automatically changes or stops the air flow from the indoor unit so that the people in the room do not feel chilly.

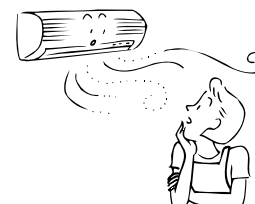

**A white mist of chilled air or water is generated from the outdoor unit.**

- Steam is sometimes generated from the indoor unit during cooling operation or the outdoor unit during defrosting operation.



**Automatic operation of vertical air flow louvers (heat pump models)**

- When the room temperature or outdoor temperature is high during the heating operation, the vertical air flow louvers close once and then set themselves automatically to the original position setting again.

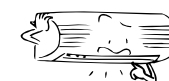

These are not defects.

Before asking for servicing or repairs, check the following points.

**The FILTER indicator turns on.**

- This indicator turns on after PURE operation has been performed for approximately 1000 hours.
- The indicator may turn on if the front panel is not firmly closed.
- The indicator may turn on if the plasma pure filter is not securely attached.

**Sounds made from the indoor unit**

- The plasma pure filter may make a humming, clicking, or buzzing sound when it is dirty.
- When the power is turned on or the air conditioner is stopped, the vertical air louvers may make a rattling sound or shuttling sound.
- Some parts may expand or shrink due to temperature fluctuations, and this can result in a slapping sound.
- When the refrigerant is flowing, a hissing sound or gurgling sound can result.
- A buzzing sound is sometimes made from the air ionizer.
- A hissing sound can be made when the air conditioner is switched to defrosting operation during heating operation.

**Sounds made from the outdoor unit (heat pump models)**

- A rustling sound can be made when the air conditioner is switched to defrosting operation during heating operation.

These are not defects.

# SPECIFICATIONS

Type	Reverse cycle, Split type			
Model	Indoor Unit	Outdoor Unit	Indoor Unit	Outdoor Unit
	RAS-B10GKVP-E	RAS-10GAVP-E	RAS-B13GKVP-E	RAS-13GAVP-E
Power supply	220–240 V ~50 Hz 220 V ~60 Hz		220–240 V ~50 Hz 220 V ~60 Hz	
Cooling capacity (kW) CAPA.	2.5		3.5	
Heating capacity (kW) CAPA.	3.2		4.2	
Cooling current (A) AMP.	0.15	2.48–2.26	0.15	4.25–3.89
Cooling power (W) WATT.	30	520	30	890
Heating current (A) AMP.	0.15	3.25–2.96	0.15	4.52–4.13
Heating power (W) WATT.	30	680	30	1,060
Dimensions	Width (mm)	790	780	780
	Height (mm)	250	550	550
	Depth (mm)	215	290	290
Net weight (kg)	9	35	9	37

Type	Reverse cycle, Split type	
Model	Indoor Unit	Outdoor Unit
	RAS-B16GKVP-E	RAS-16GAVP-E
Power supply	220–240 V ~50 Hz 220 V ~60 Hz	
Cooling capacity (kW) CAPA.	4.5	
Heating capacity (kW) CAPA.	5.5	
Cooling current (A) AMP.	0.15	6.45–5.90
Cooling power (W) WATT.	30	1,350
Heating current (A) AMP.	0.15	7.07–6.47
Heating power (W) WATT.	30	1,480
Dimensions	Width (mm)	790
	Height (mm)	250
	Depth (mm)	215
Net weight (kg)	9	37

- These specifications are subject to change without notice for the purpose of incorporating technical improvements.

The specified air-conditioning performance is based on the data determined under the following conditions.

### For cooling

Air inlet temperature °C			
Indoor coil assembly		Outdoor coil assembly	
Dry bulb	Wet bulb	Dry bulb	Wet bulb
27	19	35	24





### For heating (heat pump models)

Air inlet temperature °C			
Indoor coil assembly		Outdoor coil assembly	
Dry bulb	Wet bulb	Dry bulb	Wet bulb
20	—	7	6



For details on the specifications when used in combination with a multi air conditioner outdoor unit, refer to the specifications table provided with the multi air conditioner outdoor unit.

# TROUBLESHOOTING (Remote Control)

Before asking for servicing or repairs, check the following points.

The remote control does not operate correctly.		
Symptoms	Causes	Description and Remedy
The operating mode switches.	<ul style="list-style-type: none"> <li>Check whether the MODE indicated on the display is AUTO.</li> </ul> <p style="text-align: center;"><b>AUTO</b></p>	The fan speed and louver direction cannot be changed in AUTO mode. When the SWING, FIX or FAN buttons are pressed in AUTO mode, the mode changes to A mode.
The fan speed cannot be changed.	<ul style="list-style-type: none"> <li>Check whether the MODE indicated on the display is : DRY.</li> </ul> <p style="text-align: center;"> : <b>DRY</b></p>	When dry operation is selected, the air conditioner automatically selects the fan speed. The fan speed can be selected during  COOL,  HEAT, A and  FAN ONLY.

The Display Goes Off		
Symptoms	Causes	Description
The indicators on the display are not shown after a short time.	<ul style="list-style-type: none"> <li>Check whether the timer operation is over when the OFF TIMER is shown on the display.</li> </ul>	The air conditioner stops since the setting time has elapsed.
The TIMER display turns off after a certain period of time.	<ul style="list-style-type: none"> <li>Check whether the timer operation has started when the ON TIMER is shown on the display.</li> </ul> <p style="text-align: center;"> : <b>ON</b></p>	When the time reaches the time setting for the ON timer operation, the air conditioner starts to operate automatically and the ON timer display turns off.

The Signal Receiving Tone Does Not Sound		
Symptoms	Causes	Description
No receiving tone is made from the indoor unit even when the  button is pushed.	<ul style="list-style-type: none"> <li>Check whether the infrared signal transmitter of the remote control is properly pointed towards the receiver of the indoor unit when the  button is pushed.</li> </ul>	Point the infrared signal transmitter of the remote control towards the receiver of the indoor unit, and then press the  button repeatedly.

**This product is compliant with Directive 2002/95/EC, and cannot be disposed as unsorted municipal waste.**

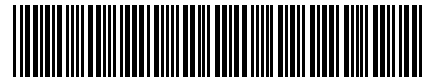

# **TOSHIBA CARRIER CORPORATION**