

TOSHIBA



**OWNER'S MANUAL
MANUEL DU PROPRIETAIRE
BETRIEBSANLEITUNG
MANUALE DEL PROPRIETARIO
MANUAL DEL PROPIETARIO
MANUAL DO UTILIZADOR
GEBRUIKSAANWIJZING
ΟΔΗΓΙΕΣ ΧΡΗΣΗΣ
用戶手冊**

For commercial use
Pour usage commercial
Nur für gewerbliche Nutzung
Per uso commerciale
Para uso comercial
Para uso comercial
Voor commercieel gebruik
Για εμπορική χρήση
商用



Indoor Unit

<4-way Air Discharge Cassette Type>

MMU-AP0091H, AP0121H, AP0151H, AP0181H,
MMU-AP0241H, AP0271H, AP0301H, AP0361H,
MMU-AP0481H, AP0561H

<2-way Air Discharge Cassette Type>

MMU-AP0071WH, AP0091WH, AP0121WH,
MMU-AP0151WH, AP0181WH, AP0241WH,
MMU-AP0271WH, AP0301WH

<1-way Air Discharge Cassette Type>

MMU-AP0071YH, AP0091YH, AP0121YH,
MMU-AP0151SH, AP0181SH, AP0241SH,
MMU-AP0152SH, AP0182SH, AP0242SH

<Concealed Duct Standard Type>

MMD-AP0071BH, AP0091BH, AP0121BH,
MMD-AP0151BH, AP0181BH, AP0241BH,
MMD-AP0271BH, AP0301BH, AP0361BH,
MMD-AP0481BH, AP0561BH

<Slim Duct Type>

MMD-AP0071SPH(SH), AP0091SPH(SH),
MMD-AP0121SPH(SH), AP0151SPH(SH), AP0181SPH(SH)

<Concealed Duct High Static Pressure Type>

MMD-AP0181H, AP0241H, AP0271H, AP0361H, AP0481H, AP0721H, AP0961H

<Under Ceiling Type>

MMC-AP0151H, AP0181H, AP0241H, AP0271H, AP0361H, AP0481H

<High Wall Type>

MMK-AP0071H, AP0072H, AP0091H,
MMK-AP0092H, AP0121H, AP0122H,
MMK-AP0151H, AP0181H, AP0241H

<Floor Standing Cabinet Type>

MML-AP0071H, AP0091H, AP0121H,
MML-AP0151H, AP0181H, AP0241H

<Floor Standing Concealed Type>

MML-AP0071BH, AP0091BH, AP0121BH,
MML-AP0151BH, AP0181BH, AP0241BH

<Floor Standing Type>

MMF-AP0151H, AP0181H, AP0241H, AP0271H,
MMF-AP0361H, AP0481H, AP0561H

Outdoor Unit

Heat Pump Model

<Inverter Unit>

MMY-MAP0501HT8, MAP0601HT8,
MMY-MAP0801HT8, MAP1001HT8,
MMY-MAP1201HT8

Cooling Only Model

<Inverter Unit>

MMY-MAP0501T8, MAP0601T8,
MMY-MAP0801T8, MAP1001T8,
MMY-MAP1201T8

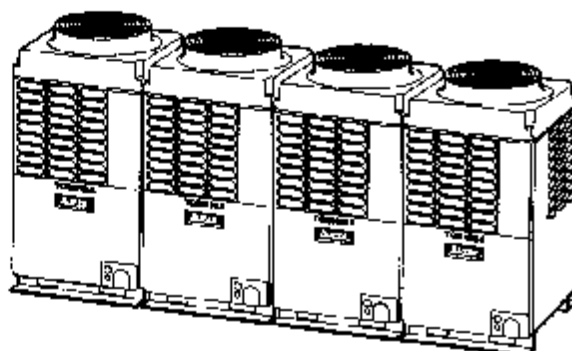

ADOPTION OF NEW REFRIGERANT

This Air Conditioner is a new type which adopts a new refrigerant HFC (R410A) instead of the conventional refrigerant R22 in order to prevent destruction of the ozone layer.

Thank you very much for purchasing TOSHIBA Air Conditioner. Please read this owner's manual carefully before using your Air Conditioner.

- Be sure to obtain the "Owner's manual" and "Installation manual" from constructor (or dealer).

Request to constructor or dealer

Please clearly explain the contents of the Owner's manual and hand over it.

UTILISATION DU NOUVEAU REFRIGERANT

Ce climatiseur est d'un type inédit qui utilise le nouveau réfrigérant HFC (R410A) au lieu du réfrigérant traditionnel R22, afin d'éviter la destruction de la couche d'ozone.

Nous vous remercions pour avoir choisi un climatiseur TOSHIBA.

Veuillez lire attentivement ce Manuel du propriétaire avant d'utiliser votre climatiseur.

- Assurez-vous que le constructeur (ou le revendeur) vous remette le "Manuel du propriétaire" et le "Manuel d'installation".

Demande au constructeur ou au revendeur

Veuillez expliquer clairement le contenu du Manuel du propriétaire et le remettre au client.

EINFÜHRUNG EINES NEUEN KÜHLMITTELS

Dies ist ein neuartiges Klimagerät. Anstatt des herkömmlichen Kühlmittels R22 verwendet es das neue ozonschicht-schonende HFC Kühlmittel R410A.

Wir danken Ihnen, dass Sie sich für ein TOSHIBA Klimagerät entschieden haben.

Bitte lesen Sie diese Betriebsanleitung, bevor Sie Ihr Klimagerät benutzen, sorgfältig.

- Lassen Sie sich die "Betriebsanleitung" und das "Installations-Handbuch" unbedingt vom Installateur oder vom Lieferanten aushändigen.

Eine Bitte an den Installateur oder Lieferanten:

Bitte erklären Sie dem Käufer den Inhalt der Betriebsanleitung und händigen sie ihm aus.

ADOZIONE DI UN NUOVO REFRIGERANTE

Questo condizionatore d'aria è di un tipo nuovo che adotta un nuovo refrigerante HFC (R410A) al posto del refrigerante convenzionale R22, per prevenire la distruzione dello strato di ozono dell'atmosfera terrestre.

Grazie di aver acquistato un condizionatore d'aria TOSHIBA.

Prima di usare il condizionatore d'aria, leggere con attenzione questo manuale del proprietario.

- Si raccomanda di tenere a portata di mano il "Manuale del proprietario" e il "Manuale di installazione" ricevuti dal produttore (o dal rivenditore).

Richiesta al produttore o al rivenditore

Spiegare chiaramente il contenuto del Manuale del proprietario e consegnarne una copia all'utente.

ADOPCIÓN DE NUEVO REFRIGERANTE

Este aparato de aire acondicionado es un modelo reciente que incorpora el nuevo refrigerante HFC (R410A) en lugar del refrigerante convencional R22 para así evitar daños en la capa de ozono.

Muchas gracias por haber adquirido el aparato de aire acondicionado TOSHIBA. Lea atentamente este manual del propietario antes de utilizar el aparato de aire acondicionado.

- Asegúrese de que el fabricante (o distribuidor) le proporcione el "Manual del propietario" y el "Manual de instalación".

Solicítalo al fabricante o distribuidor

Explique con claridad el contenido del Manual del propietario y entréguelo al cliente.

ADOPÇÃO DO NOVO REFRIGERANTE

Este ar condicionado é um modelo novo que adopta um novo refrigerante HFC (R410A) em vez do refrigerante convencional R22 para evitar a destruição da camada de ozono.

Muito obrigada por adquirir o Ar Condicionado TOSHIBA.

Leia atentamente este manual do utilizador antes de utilizar o seu ar condicionado.

- Não se esqueça de receber o "Manual do utilizador" e o "Manual de instalação" do fabricante (ou agente).

Pedido ao fabricante ou agente

Explique por favor o conteúdo do Manual do Utilizador e entregué-o.

TOEPASSING VAN EEN NIEUW KOELMIDDEL

Deze airconditioner is een nieuwe type dat werkt met een nieuw koelmiddel HFC (R410A) in plaats van met het conventionele koelmiddel R22, als bijdrage om de aantasting van de ozonlaag te reduceren.

Hartelijk dank voor uw keuze voor een airconditioner van TOSHIBA.

Lees deze gebruiksaanwijzing zorgvuldig door voordat u de airconditioner gaat gebruiken.

- Zorg ervoor dat u zowel de 'gebruiksaanwijzing' als de 'installatiehandleiding' van de installateur (of leverancier) krijgt.

Verzoek aan de installateur of de leverancier:

Leg de inhoud van de gebruiksaanwijzing duidelijk uit en overhandig de gebruiksaanwijzing raden aan de klant.

ΥΠΟΒΕΤΗΣΗ ΝΕΟΥ ΨΥΚΤΙΚΟΥ

Το παρόν Κλιματιστικό είναι νέος τύπος που υιοθετεί νέο ψυκτικό HFC (R410A) στη θέση του συμβατικού ψυκτικού R22 προκειμένου να βοηθήσει στην προστασία του όζοντος.

Σας ευχαριστούμε πολύ που προτιμήσατε για την αγορά σας ένα Κλιματιστικό TOSHIBA.

Παρακαλούμε διαβάστε προσεκτικά τις οδηγίες χρήσης πριν από τη χρήση του Κλιματιστικού.

- Βεβαιωθείτε ότι ο κατασκευαστής (ή ο πωλητής) σας παρέδωσε και τις "Οδηγίες Χρήσης" και το "Εγχειρίδιο Εγκατάστασης".

Παράκληση για τον κατασκευαστή ή τον πωλητή

Παρακαλώ εξηγήστε με σαφήνεια τα περιεχόμενα των Οδηγιών Χρήσης και παραδώστε το.

采用新的冷媒

为了防止破坏臭氧层, 本空调采用最新冷媒 HFC (R410A), 而非普通的冷媒 R22.

承蒙选购东芝空调, 谨在此表示由衷的感谢。

使用本空调前, 请熟读本用户使用手册。

- 必须向合同签订人(或 销售商)领取《用户手册》和《安装手册》。

对合同签订人或 销售商的要求:

请清楚地说明使用手册的内容, 然后把使用手册交给用户。

CONTENTS

PRECAUTIONS FOR SAFETY	1	INSTALLATION	17
NAME OF EACH PART	3	MAINTENANCE	19
PARTS NAME OF REMOTE CONTROLLER	6	AIR CONDITIONER OPERATIONS AND PERFORMANCE	22
CORRECT USAGE	8	RE-INSTALLATION	23
ADJUSTMENT OF WIND DIRECTION	9	WHEN THE FOLLOWING SYMPTOMS ARE FOUND	24
TIMER OPERATION	16		

SOMMAIRE

MESURES DE SECURITE	26	INSTALLATION	42
NOM DE CHAQUE PIÈCE	28	ENTRETIEN	43
NOM DES PIÈCES DE LA TELECOMMANDE	31	FONCTIONNEMENT ET PERFORMANCES DU CLIMATISEUR	47
UTILISATION CORRECTE	33	REINSTALLATION	48
REGLAGE DU SENS DE SOUFFLAGE	34	EN PRÉSENCE DES SYMPTÔMES SUIVANTS	49
FONCTIONNEMENT PAR MINUTERIE	41		

INHALT

SICHERHEITSVORKEHRUNGEN	51	INSTALLATION	67
BEZEICHNUNGEN DER TEILE	53	WARTUNG	68
TEILEBEZEICHNUNG DER FERNBEDIENUNG	56	FUNKTIONEN UND LEISTUNG DES KLIMAGERÄTS	72
RICHTIGE HANDHABUNG	58	NEU-INSTALLATION	73
EINSTELLUNG DES LUFTSTROMS	59	VORGEHENSWEISE BEI FOLGENDEN SYMPTOMEN	74
ZEITBETRIEB	68		

INDICE

PRECAUZIONI PER LA SICUREZZA	76	INSTALLAZIONE	92
NOME DI OGNI PARTE	78	MANUTENZIONE	93
NOME DELLE PARTI DEL TELECOMANDO	81	OPERAZIONI E PRESTAZIONI DEL CONDIZIONATORE D'ARIA	97
USO CORRETTO	83	RE-INSTALLAZIONE	98
REGOLAZIONE DELLA DIREZIONE DELL'ARIA	84	QUANDO SI RISCOVTRANO I SINTOMI SEGUENTI	99
FUNZIONAMENTO CONTIMER	91		

CONTENIDO

PRECAUCIONES PARA SU SEGURIDAD	101	INSTALACIÓN	117
NOMBRE DE CADA COMPONENTE	103	MANTENIMIENTO	118
DESCRIPCIÓN DE LOS BOTONES DEL CONTROL REMOTO	106	FUNCIONES Y RENDIMIENTO DEL APARATO DE AIRE	
UTILIZACIÓN CORRECTA	108	ACONDICIONADO	122
AJUSTE DE LA DIRECCIÓN DEL AIRE	109	REINSTALACIÓN	123
FUNCIÓNAMIENTO DEL TEMPORIZADOR	116	CUANDO SE DETECTAN LOS SIGUIENTES SINTOMAS	124

ÍNDICE

PRECAUÇÕES DE SEGURANÇA	126	INSTALAÇÃO	142
NOMES DE CADA PEÇA	128	MANUTENÇÃO	143
NOME DAS PEÇAS DO CONTROLADOR REMOTO	131	FUNCCIONAMENTO E PERFORMANCE DO APARELHO DE AR	
UTILIZAÇÃO CORRECTA	133	CONDICIONADO	147
REGULAÇÃO DA DIRECÇÃO DO VENTO	134	REINSTALAÇÃO	148
OPERAÇÃO DO TEMPORIZADOR	141	SE FOREM DETECTADOS OS SEGUINTE SINTOMAS	149

INHOUD

VOORZORGSMAATREGELEN VOOR UW VEILIGHEID	151	DE TIMER GEBRUIKEN	166
BENAMINGEN VAN DE ONDERDELEN	153	INSTALLEREN	167
BENAMING VAN DE ONDERDELEN VAN DE		ONDERHOUD	168
AFSTANDSBEDIENING	156	BEDIENING EN WERKING VAN DE AIRCONDITIONER	172
CORRECT GEBRUIK	156	OPNIEUW INSTALLEREN	173
INSTELLEN VAN DE LUCHTSTROOMRICHTING	159	WANNEER DE VOLGENDE SYMPTOMEN AANWEZIG ZIJN	174

ΠΕΡΙΕΧΟΜΕΝΑ

ΠΡΟΦΥΛΑΞΕΙΣ ΓΙΑ ΑΣΦΑΛΕΙΑ	176	ΕΓΚΑΤΑΣΤΑΣΗ	182
ΟΝΟΜΑΣΙΑ ΤΟΥ ΚΑΘΕ ΕΞΑΡΤΗΜΑΤΟΣ	178	ΣΥΝΤΗΡΗΣΗ	183
ΟΝΟΜΑΣΙΑ ΤΜΗΜΑΤΩΝ ΤΟΥ ΤΗΛΕΧΕΙΡΙΣΤΗΡΙΟΥ	181	ΛΕΙΤΟΥΡΓΙΕΣ ΚΑΙ ΑΠΟΔΟΣΗ ΤΟΥ ΚΛΙΜΑΤΙΣΤΙΚΟΥ	197
ΟΡΘΗ ΧΡΗΣΗ	183	ΕΓΚΑΤΑΣΤΑΣΗ ΕΚ ΝΕΟΥ	198
ΡΥΘΜΙΣΗ ΤΗΣ ΚΑΤΕΥΘΥΝΣΗΣ ΤΟΥ ΑΝΕΜΟΥ	184	ΟΤΑΝ ΠΑΡΑΤΗΡΗΣΟΥΝ ΤΑ ΠΑΡΑΚΑΤΩ ΣΥΜΠΤΩΜΑΤΑ	199
ΛΕΙΤΟΥΡΓΙΑ ΧΡΟΝΟΔΙΑΚΟΠΤΗ	191		

目 录

安全注意事项	201	安 装	217
各部件名称	203	维 护	218
遥控器部件的名称	206	空调设备操作和性能	222
正确的使用方法	208	再 安 装	223
风向调节	209	当出现以下症状时	224
定时运转	216		

ENGLISH

FRANCAIS

DEUTSCH

ITALIANO

ESPAÑOL

PORTUGUES

NEDERLANDS

ΕΛΛΗΝΙΚΑ

中 文

PRECAUTIONS FOR SAFETY

▲ WARNING

Warning on installation

Be sure to leave the installation work to the dealer or a store specializing.

The exclusive knowledge and technology are required for installation work. Do not perform installation by yourself. If an incomplete installation is performed, a fire, electric shock, injury, or water leakage may be caused.

Be sure to use the products sold separately which are specified by us.

For the products sold separately, be sure to use those specified by us. Otherwise, a fire, electric shock, or water leakage may be caused. For installation work, leave it to special engineer.

When installing the units in a small room, take measures so that the refrigerant will not exceed the critical concentration if it leaks.



CAUTION

Related to countermeasures against the critical concentration, perform the installation work upon consultation with the dealer. If the refrigerant leaks and exceeds the critical concentration, oxygen deficiency may be caused.

Check whether earthing work is performed correctly.

A grounding is necessary. If the earthing work is incompletely, an electric shock may be caused. (For details, conform to the local regulation in each area.)

Warning on use

Do not expose your body directly in cool air for a long time, or do not cool you excessively.

It causes the worse of physical condition or trouble on health.

Never insert a finger or bar into the air inlet port or air outlet port of air.

Since the fan rotates in high speed inside of the unit, an injury may be caused.

When a trouble (burnt smell, etc.) is felt, stop the operation, turn off the power switch, and contact the dealer who you have purchased the air conditioner.

If keeping operation as the air conditioner is defective, a fire, electric shock, or trouble may be caused.

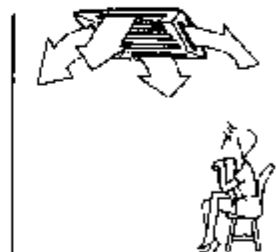
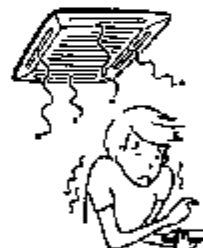

Warning on moving/repair

Never modify the air conditioner.

A fire or electric shock may be caused.

For repair, leave it to the dealer which you have purchased the air conditioner.

If an incomplete repair is performed, a fire or electric shock may be caused.

When moving or re-installing the air conditioner, contact the dealer which you have purchased the air conditioner or the special engineer.

If an incomplete installation is performed, a fire, electric shock, injury, or water leakage may be caused.



⚠ CAUTION**Caution on installation**

Check the drain pipes are installed so that they can drain water securely.

If the piping is incomplete, water leakage occurs resulted in moisture on furniture.

Check the earth leakage breaker is attached.

It is necessary to attach an earth leakage breaker. Otherwise, it causes an electric shock.

Check the air conditioner is installed at a place where flammable gas will not leak.

If gas leaks and accumulates in the unit surroundings, an outbreak of fire may be caused.

Check the outdoor unit is fixed on the base.

If it is not fixed securely on the base, an accident such as falling may be caused.

Check fixing method

Do not clean the air conditioner with water.

An electric shock may be caused.

Do not put the combustible devices at a place where air from the air conditioner flows directly.

Imperfect combustion of the combustible devices may be caused.

Diligently ventilate the room when operating the air conditioner with the combustible devices.

If ventilation is incomplete, shortage of oxygen may be caused.

Check the installation plate, etc. is not damaged by use for a long time.

If leaving them damaged, the unit may fall resulted in injury, etc.

Do not put plants and animals at a place where air from the air conditioner flows directly.

Cause to affect on plants and animals may generate.

Do not put flammable spray, etc. near the air conditioner, or do not spray directly on the air conditioner.

A fire may be caused.

Do not put vessels including water such as a vase on the unit.

Moisture floods in the unit, the electric isolation deteriorates, and an electric shock may be caused.

Do not handle the switches with wet hands.

An electric shock may be caused.

Do not use the air conditioner for special purpose such as storage of foods, plants and animals, precise equipment, and art works.

Deterioration of quality may be caused.

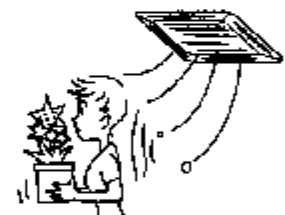
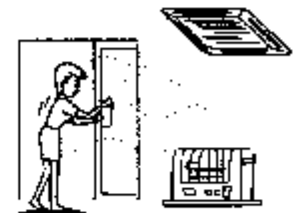
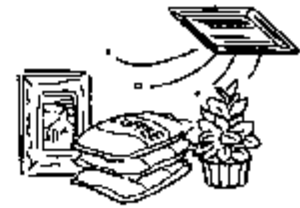

NAME OF EACH PART

Indoor unit

[4-way Air Discharge Cassette Type]

Air outlet/Air outlet flap

Select air blow direction in cooling or heating operation each

Earth screw

It is included in the electric parts box.

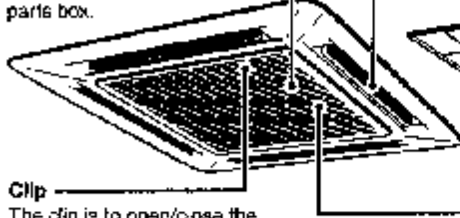

Clip

The clip is to open/close the air inlet grille.

2-way discharge/3-way discharge

2-way discharge or 3-way discharge can be selected according to the shape or arrangement of the room. For details, consult with the dealer which you have purchased the air conditioner.

Air filter

Removes dust and trash. (Air filter is provided in the air grille.)

Air inlet grille

Air in the room is sucked from here.

[2-way Air Discharge Cassette Type]

Earth screw

It is included in the electric parts box.

Center panel

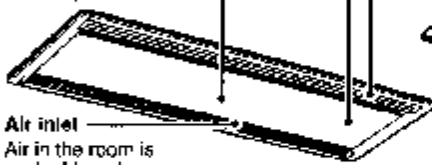

Air inlet

Air in the room is sucked from here.

Air outlet/Air outlet flap

Select air blow direction in cooling or heating operation each

Air filter

Removes dust and trash. (Air filter is provided in the center panel.)

[1-way Air Discharge Cassette Type]

MMU-AP0071YH to AP0121YH

Air outlet/Air outlet flap

Select air blow direction in cooling or heating operation each.

Earth screw

It is included in the electric parts box.

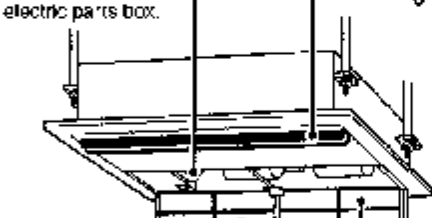

Air inlet grille

Air in the room is sucked from here.

Air filter

Removes dust and trash. (Air filter is provided in the air inlet grille.)

MMU-AP0151SH to AP0241SH

Earth screw

It is included in the electric parts box.

Air outlet/Air outlet flap

Select air blow direction in cooling or heating operation each.

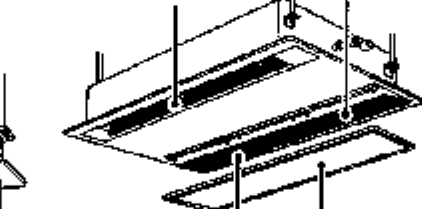

Air inlet grille

Air in the room is sucked from here.

Air filter

Removes dust and trash. (Air filter is provided in the air inlet grille.)

MMU-AP0152SH, AP0182SH, AP0242SH

Button

Button to open/close suction port

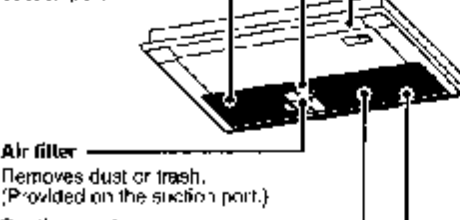

Air filter

Removes dust or trash. (Provided on the suction port.)

Suction port

Sucks air inside of the room from here.

Earth screw

It is included in the electric parts box.

Air outlet/Air outlet flap

Change the direction of the air to be discharged according to cool/heat mode.

Air filter

Removes dust or trash. (Provided on the suction port.)

Sold Separately Parts

Main remote controller

RBC-AMT31E

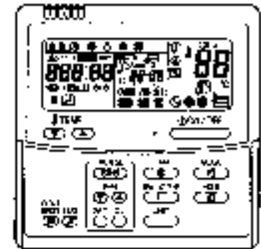

Sub-remote controller

RBC-AS21E2

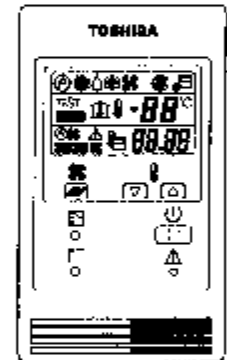

Wireless remote controller kit

RBC-AX21UW-E2

RBC-AX22CE2

TCB-AX21E2



[Concealed Duct Type]

Air outlet flange

Discharge duct is connected.

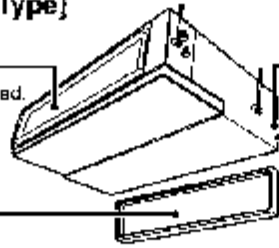

Earth screw

Earth screws are provided in the electric parts box.

Air filter

Removes dust and trash. (Air filter is provided in the air inlet grille.)

Air inlet

Air in the room is sucked from here.

[Concealed Duct, High Static Pressure Type]

Air outlet

Discharge duct is connected.

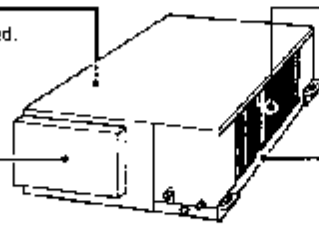

Air inlet

Suction duct is connected.

Earth screw

Earth screws are provided in the electric parts box.

Drain pan

[Slim Duct Type]

Air Inlet

Suction duct is connected.

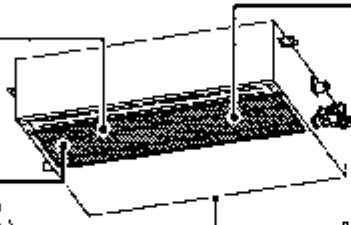

Earth screw

It is included in the electric parts box.

Air filter

(Air filter is not provided to some models in the series.)

Air outlet

Discharge duct is connected.

[Under Ceiling Type]

Button

Button to open/close the suction port.

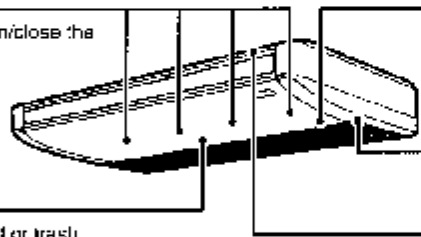

Air inlet port

The air in the room is sucked in from this port.

Air filter

Removes dust or trash. (Provided on the suction port.)

Earth screw

Earth screws are provided in the electric parts box.

Air outlet/Air outlet flap

Change the direction of the air to be discharged according to cool/heat mode.

[High Wall Type]

MMK-AP0071H to AP0241H

Air inlet grille

Air in the room is sucked from here.

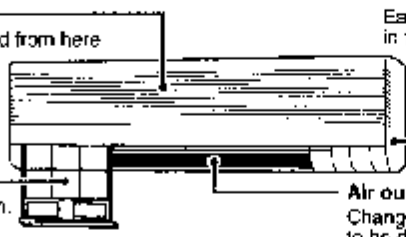

Earth screw

Earth screws are provided in the electric parts box.

Air filter

Removes dust and trash. (Air filter is provided in the air inlet grille.)

Air outlet/Air outlet flap

Change the direction of the air to be discharged according to cool/heat mode.

MMK-AP0072H to AP0122H

Air inlet grille

Air in the room is sucked from here.

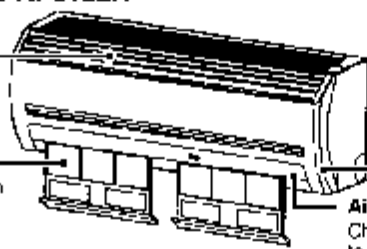

Earth screw

Earth screws are provided in the electric parts box.

Air filter

Removes dust and trash. (Air filter is provided in the air inlet grille.)

Air outlet/Air outlet flap

Change the direction of the air to be discharged according to cool/heat mode.

Weekly timer
RBC-EKW21E2



Central remote controller
TCB-SC642TLE2

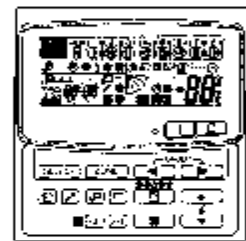

[Floor Standing Cabinet Type]

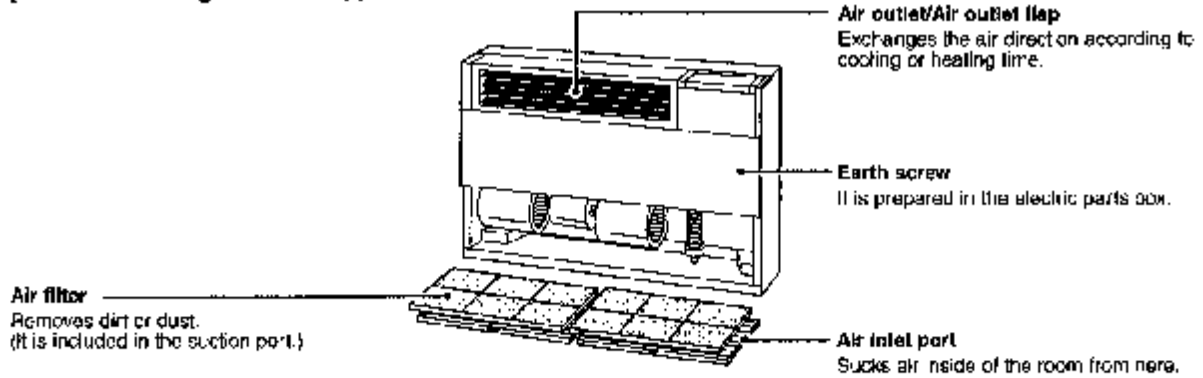

[Floor Standing Concealed Type]

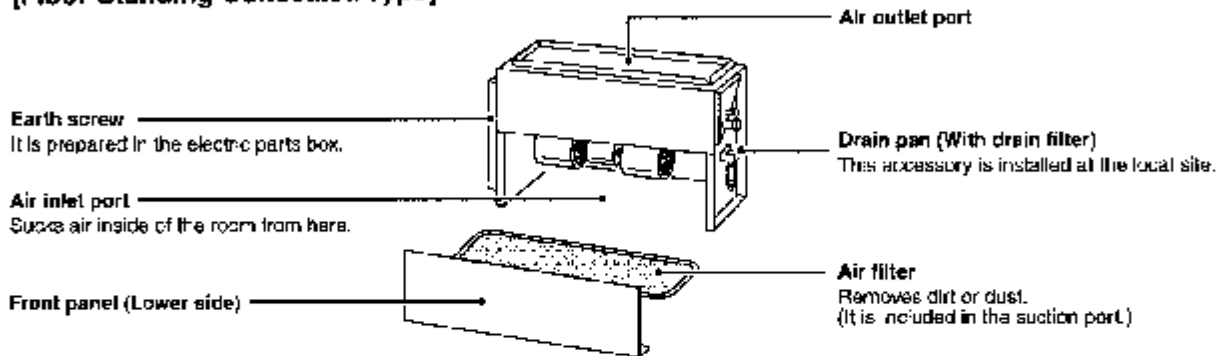

[Floor Standing Type]

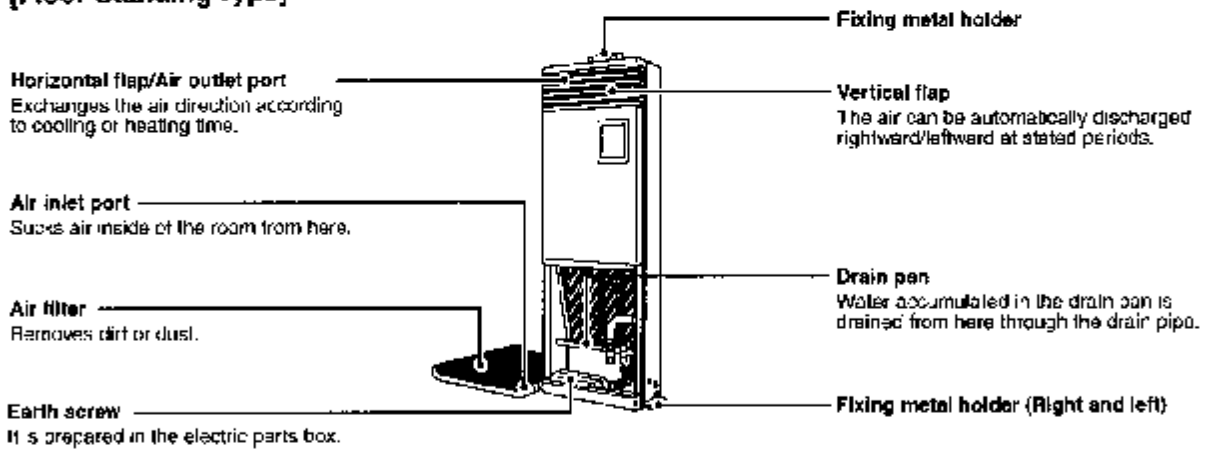

Outdoor unit

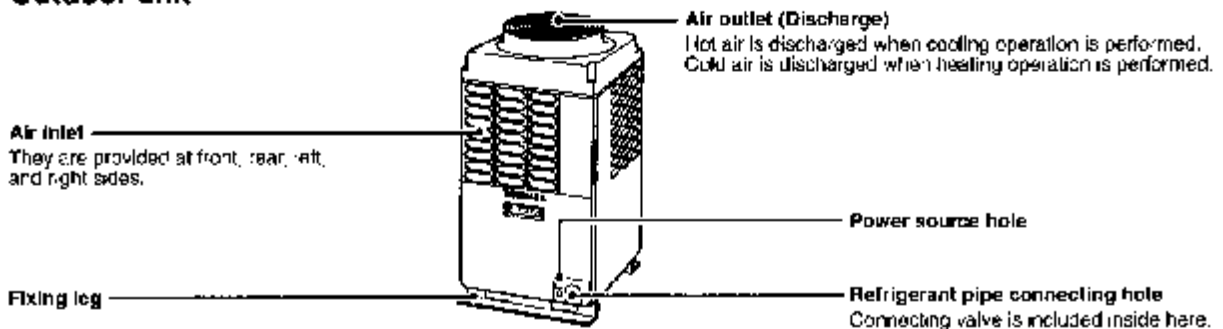

PARTS NAME OF REMOTE CONTROLLER

Display section

In the display example, all indicators are displayed for the explanation.

In reality only, the selected contents are indicated.

- When turning on the break breaker at the first time, [SET DATA] flashes on the display part of the remote controller. While this display is flashing, the model is being automatically confirmed. Accordingly, wait for a while after [SET DATA] display has disappeared, and then use the remote controller.

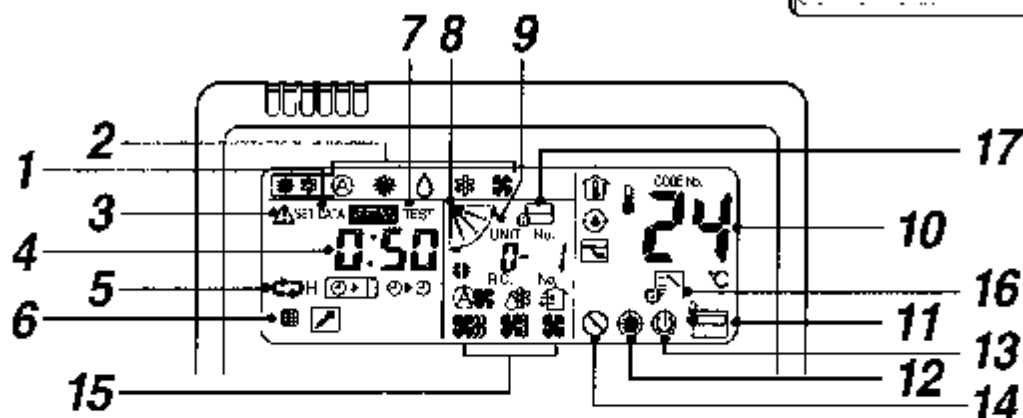
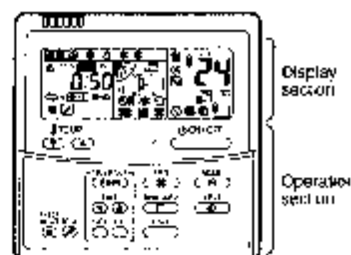

- 1 SET DATA display**
Displayed during setup of the timer.
- 2 Operation mode select display**
The selected operation mode is displayed.
- 3 CHECK display**
Displayed while the protective device works or a trouble occurs.
- 4 Timer time display**
Time of the timer is displayed.
(When a trouble occurs, the check code is displayed.)
- 5 Timer SETIN setup display**
When pushing the Timer SETIN button, the display of the timer is selected in order of [OFF] (OFF) → [ON] (ON) → No display.
- 6 Filter display**
If "FILTER" is displayed, clean the air filter.
- 7 TEST run display**
Displayed during a test run.
- 8 Flap position display (for 4-Way Air Discharge Cassette Type and Under Ceiling Type model only)**
Displays flap position.
- 9 SWING display**
Displayed during up/down movement of the flap.
- 10 Set up temperature display**
The selected set up temp. is displayed.
- 11 Remote controller sensor display**
Displayed while the sensor of the remote controller is used.
- 12 PRE-HEAT display (for Heat-pump model only)**
Displayed when the heating operation starts or defrost operation is carried out.
While this indication is displayed, the indoor fan stops or the mode enters in LOW.
- 13 Operation ready display**
Displayed when cooling or heating operation is impossible because the outdoor temperature goes out of the operable range.
- 14 No function display**
Displayed if there is no function even if the button is pushed.
- 15 Air volume select display**
The selected air volume mode is displayed.
(AUTO) (HIGH)
(MED.) (LOW)
- 16 Mode select control display**
Displayed when pushing "Operation mode select" button while the operation mode is fixed to heating or cooling by the system manager of the air conditioner.
- 17 Central control display**
Displayed when using the remote controller together with the central control remote controller, etc.
If Remote controller is prohibited at the central control side, flashes when operating (ON/OFF) (OFF) / (ON/OFF) buttons and the change is not accepted.
(The contents available to be set up on the remote controller differ according to the central control mode. For details, refer to Owner's Manual of the central control remote controller.)

Operation section

Push each button to select a desired operation.

This remote controller can operate the maximum 8 indoor units.

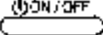
- The details of the operation needs to be set up once, afterward, the air conditioner can be used by pushing  button only.

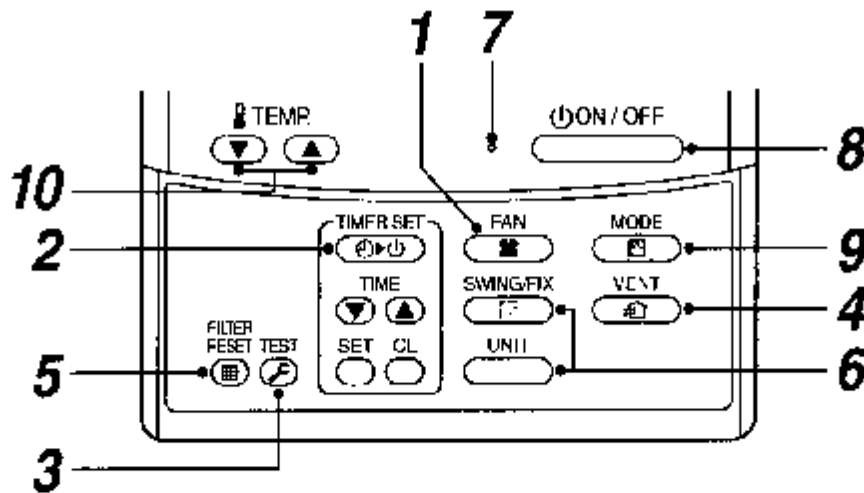

1 Air volume select button

Selects the desired air volume mode.

The Concealed Duct High Static Pressure type models cannot be operated.

2 Timer set button

TIMER SET button is used when the timer is set up.

3 Check button

The CHECK button is used for the check operation. During normal operation, do not use this button.

4 Fan button

FAN button is used when a fan which is sold on the market or etc. is connected.

- If  is displayed on the remote controller when pushing the FAN button, a fan is not connected.

5 Filter reset button

Resets (Erases) "FILTER  " display.

6 Wind direction and Swing

 :

If the multiple indoor units are operated by only one remote controller, select the units when the air direction is adjusted.

 :

Set up the auto swing and angle of the flap.

- This function is not provided to Concealed Duct Standard Type, High Static Pressure Type, Floor standing Cabinet Type, or Floor Standing Concealed Type.

7 Operation lamp

Lamp is lit during the operation. Lamp is off when stopped.

Although it flashes when operating the protection device or abnormal time.

8 button

When the button is pushed, the operation starts, and it stops by pushing the button again.



When the operation has stopped, the operation lamp and all the displays disappear.

9 Operation select button

Selects desired operation mode.

10 Set up temperature button

Adjusts the room temperature.

Set the desired set temperature by pushing  or .

OPTION :

Remote controller sensor

Usually the TEMP. sensor of the indoor unit senses the temperature. The temperature on the surrounding of the remote controller can also be sensed. For details, contact the dealer from which you have purchased the air conditioner.

- In case that one remote controller controls the multiple indoor units, the setup operation is unavailable in group control.

CORRECT USAGE

When you use the air conditioner for the first time or when you change the SET DATA value, follow the procedure below. From the next time, the operation displayed on the remote controller will start by pushing the  button only.

Preparation

Turn on the main power switch and/or the leakage breaker.

- When the power supply is turned on, a partition line is displayed on the display part of the remote controller.
- * After the power supply is turned on, the remote controller does not accept an operation for approx. 1 minute, but it is not a failure.

REQUIREMENT

- While using the air conditioner, operate it only with  button without turning off the main power switch and the leak breaker.
- Do not turn off the leak breaker while the air conditioner is used.
- Turn on the leak breaker 12 hours or more before start of operation after the air conditioner has stopped for a long time.

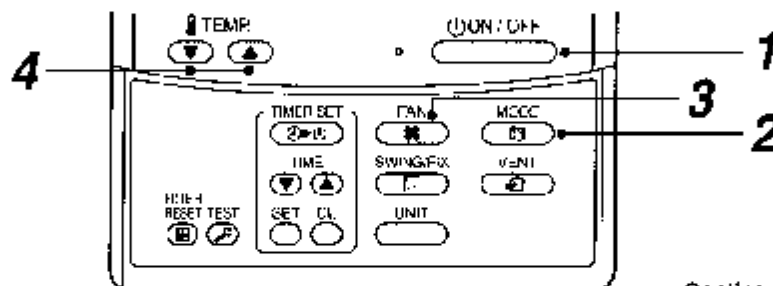

1 Push button.

The operation lamp goes on, and the operation starts.







2 Select an operation mode with the button.

One push of the button, and the display changes in the order shown on the right.

- "DRY  mode" function is not provided to Concealed Duct High Static Pressure Type.

3 Select air volume with button.

One push of the button, and the display changes in the order shown on the right.

- When air volume is "AUTO ", air volume differs according to the room temperature.
- In DRY  mode, "AUTO " is displayed and the air volume is LOW.
- In heating operation, if the room temperature is not heated sufficiently with volume "LOW " operation, select "MED. " or "HIGH " operation.
- The temperature which the temperature sensor detects is one near the air inlet of the indoor unit. Therefore it slightly differs from the room temperature according to the installation status. The setup value is a criterion of the room temperature. (Automatic air speed cannot be selected in FAN mode.)
- Air volume of function is not provided to "Concealed Duct High Static Pressure Type" but air speed "HIGH " only is displayed.

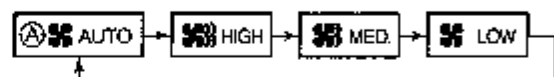
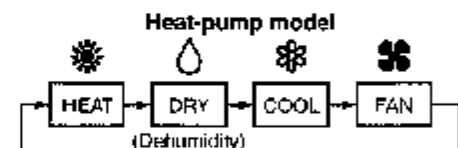
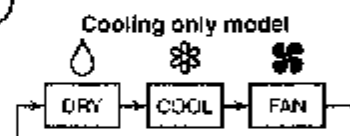

4 Determine the set up temperature by pushing the "TEMP. " or "TEMP. " button.

Stop

Push  button.

The operation lamp goes off, and the operation stops.

REQUIREMENT

[In Cooling operation]

- The operation starts after approx. 1 minute.

[In Heating operation (For Heat-pump model only)]

- In heating operation, the fan operation may continue for approx. 30 seconds after the air conditioner has stopped.
- The indoor fan continues preheat operation for 3 to 5 minutes under stop condition, and then blows out the hot air.
(☀ display on the remote controller display part goes on.)
- When temperature of the room has reached the setup temperature and the outdoor unit stops, the air speed becomes super low and the air volume extremely is lessened.
- In HEAT ☀ mode, if the room temperature reaches to the set temperature, the outdoor unit stops and the air flow becomes LOW and the air volume decreases.
- In the defrost mode, the fan stops so that cool air is not discharged and PRE-DEF ☀ is displayed.

ADJUSTMENT OF WIND DIRECTION

To increase the cooling or heating effect, be sure to use the discharge flap in the different directions in cooling or heating operation.

As the characteristics of the air, the cold air accumulates at lower side and hot air at upper side, respectively.

CAUTION

Set the louver horizontally in cooling operation.

If cooling operation is performed with downward discharge, the surface of the discharge port or louver will be wet with dew, and dewdrop may fall down.

REQUIREMENT

- If heating operation is performed with horizontal discharge, unevenness of temperature may increase in the room.

4-way Air Discharge Cassette Type

- While the air conditioner stops, the discharge flap automatically directs downward.
- While the air conditioner is in ready status for heating, the discharge flap directs upward.
The swinging operation starts after heating ready status has been cleared, but "SWING ↶" is displayed on the remote controller even if the status is ready to heating.

[In Cooling operation]

Use the discharge flap with horizontal set point.

[In Heating operation (For Heat-pump model only)]

Use the discharge flap with downward set point.

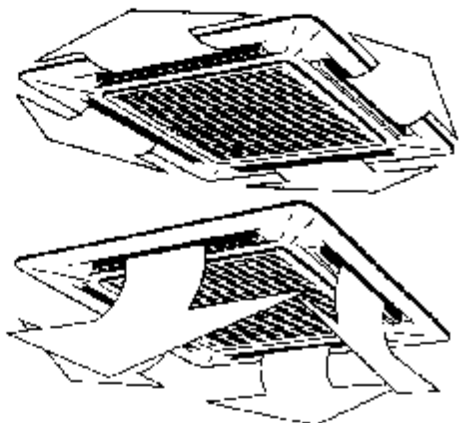

How to set up the air direction

Push  button.

- 1 Every pushing the button, the air direction changes.

In Heating operation

Set the air outlet flap downward.
If directing it upward, the hot air may not come to the foot.





In Cooling / Dry operation

Set the air outlet flap upward.
If directing it downward, the dew may fall on near the air discharge port or it drips.



How to start swinging

- 2 Push  button.
Set direction of the air outlet flap to the lowest position and then push  button again.

- [SWING ] is displayed and the air direction automatically changes upward/downward.

In case when one remote controller controls the multiple indoor units, each indoor unit can be selected and its air direction can be set up.

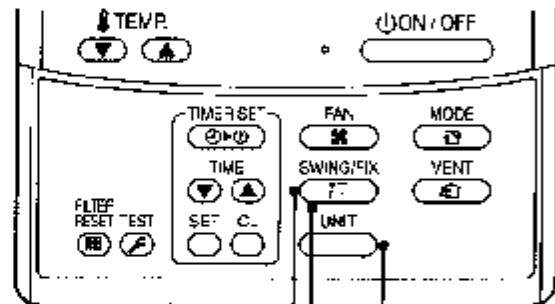



1, 2, 3 — 4

How to stop swinging

- 3 Push  button again during swinging of the air outlet flap.

- The air outlet flap can be stopped at the desired position. After then the air direction can be again set up from the uppermost position by pushing  button.
- * While the air outlet flap is set downward in cooling/drying operation, it does not stop. If stopping the air outlet flap which directs downward during swinging, it stops after moving to the 3rd position from the top position.

- 4 

- To set up the air direction individually, push  button to display each indoor unit No. in a group control. Then set up the air direction to a displayed indoor unit.
- If there is no display, all the indoor units can be operated collectively.
- Every pushing  button, the display exchanges as shown in the figure.

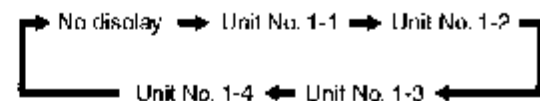
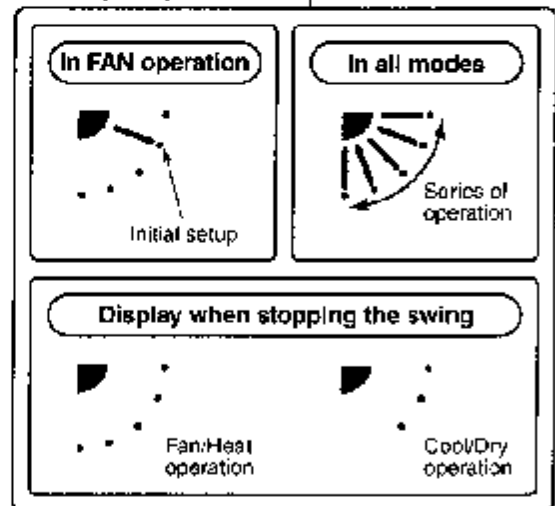

According to the shape or arrangement of the room, the cold air and hot air can be discharged for two directions or three directions. For details, contact the dealer.

INFORMATION

- If cooling operation is performed with downward discharge, dew may fall on surface of the cabinet or the horizontal flap resulted in dripping.
- If heating operation is performed with horizontal discharge, unevenness of temperature may increase in the room.
- Do not move the horizontal flap directly with hands; otherwise a trouble is caused. Select direction of the horizontal flap using flap operation switch on the remote controller. The horizontal flap does not stop immediately even if the switch is pushed. Adjusting the stop position, push the switch.

2-way Air Discharge Cassette Type

[In Cooling operation]

Use the air outlet flap with horizontal set point.

[In Heating operation (For Heat-pump model only)]

Use the air outlet flap with downward set point.

Setup of air direction and swinging

1 Push button during operation.



- [SWING ] is displayed and the air direction automatically changes upward/downward.

In case when one remote controller controls the multiple indoor units, each indoor unit can be selected and its air direction can be set up.

2 Push button again during swinging of the air outlet flap.

- The air outlet flap can be stopped at the desired position.

3

- To set up the air direction individually, push  button to display each indoor unit No. in a group control. Then set up the air direction to a displayed indoor unit.
- If there is no display, all the indoor units can be operated collectively.
- Every pushing  button, the display exchanges as shown in the figure.

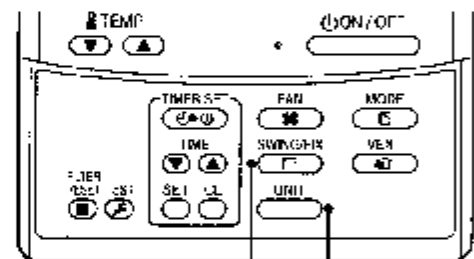
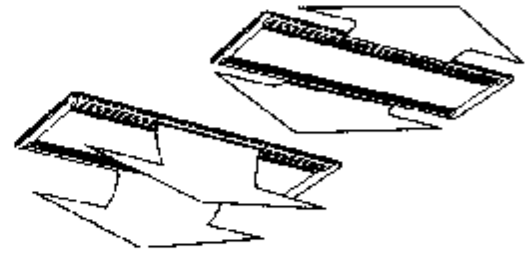

1, 2 — 3

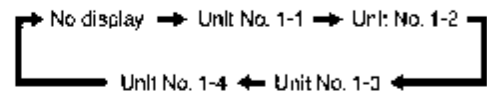

1-way Air Discharge Cassette Type

Adjustment of air direction upward/downward

[In Cooling operation]

In cooling operation, use the air outlet flap with horizontal set point so that the cold air diffuses in whole room.

[In Heating operation (For Heat-pump model only)]

In heating operation, use the air outlet flap with downward set point so that the hot air blows at the foot.

Adjustment of air direction rightward/leftward

To change the discharge direction to right or left side, set the vertical grille inside of the air outlet flap to the desired direction.

Setup of air direction and swinging

Refer to description of "2-way Air Discharge Cassette Type".

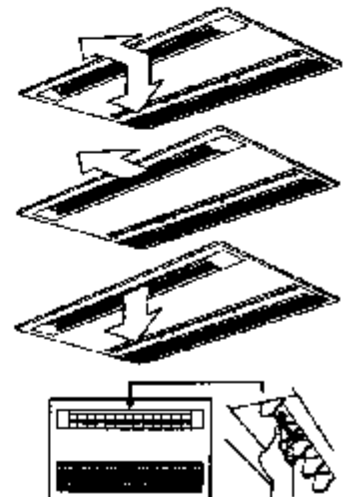

Under Ceiling Type

- While the air conditioner stops, the horizontal flap (Up/Down air direction adjustment plate) automatically directs upward.
- While the air conditioner is in ready status for heating, the horizontal flap (Up/Down air direction adjustment plate) directs upward. The swinging operation starts after heating ready status has been cleared, but "SWING" is displayed on the remote controller even if the status is ready to heating.

How to set up the air direction

Push  button during operation.

1 Every pushing the button, the air direction changes.

In Heating operation

Set the horizontal flap (Up/Down air direction adjustment plate) downward. If directing it upward, the hot air may not come to the foot come to the foot.



In Cooling / Dry operation

Set the horizontal flap (Up/Down air direction adjustment plate) upward. If directing it downward, the dew may fall on near the air air outlet: port or it drips.



How to start swinging

2 Push  button.

Set direction of the horizontal flap (Up/Down air direction adjustment plate) to the lowest position and then push  button again.

- [SWING] is displayed and the air direction automatically changes upward/downward.



In case when one remote controller controls the multiple indoor units, each indoor unit can be selected and its air direction can be set up.

How to stop swinging

3 Push  button again during swinging of the horizontal flap.

- The horizontal flap can be stopped at the desired position. After then the air direction can be again set up from the uppermost position by pushing  button.
- While the horizontal flap is set downward in cooling/drying operation, it does not stop. If stopping the horizontal flap which directs downward during swinging, it stops after moving to the 3rd position from the top position.

4 

- To set up the air direction individually, push  button to display each indoor unit No. in a group control. Then set up the air direction to a displayed indoor unit.
- If there is no display, all the indoor units can be operated collectively.
- Every pushing  button, the display exchanges as shown in the figure.

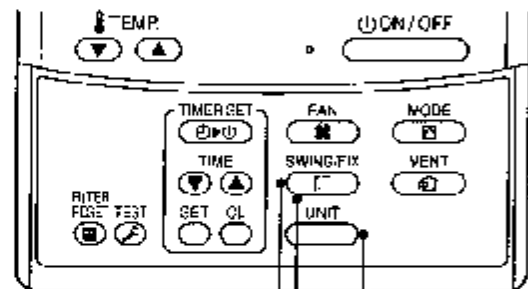
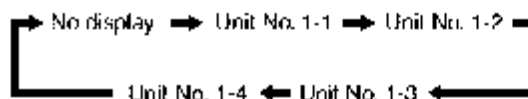

1, 2, 3 — 4

In FAN operation



In all modes



Display when stopping the swing

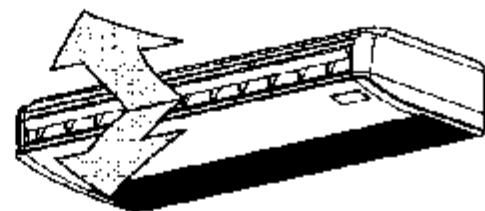

Right/Left air direction adjustment

To change the air outlet direction to right or left side, set the vertical flap inside of the horizontal flap to the desired direction.

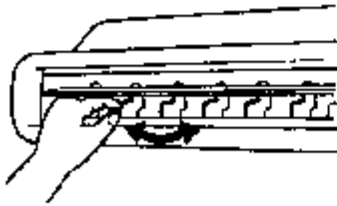

INFORMATION

- If cooling operation is performed with downward discharge, dew may fall on surface of the cabinet or the horizontal flap resulted in dripping.
- If heating operation is performed with horizontal discharge, unevenness of temperature may increase in the room.

High Wall Type

Adjustment of air direction upward/downward

[In Cooling operation]

In cooling operation, use the horizontal flap with horizontal set point so that the cold air diffuses in whole room.

[In Heating operation (For Heat-pump model only)]

In heating operation, use the horizontal flap with downward set point so that the hot air blows at the foot.

REQUIREMENT

- If cooling operation is performed with downward air outlet, dew may fall on surface of the cabinet or the horizontal flap resulted in dripping.
- If heating operation is performed with horizontal air outlet, unevenness of temperature may increase in the room.
- Do not move the horizontal flap directly with hands; otherwise a trouble is caused. Select direction of the horizontal flap using  switch on the remote controller. The horizontal flap does not stop immediately even if the switch is pushed. Adjusting the stop position, push the switch.

Adjustment of air direction rightward/leftward

To change the air outlet direction to right or left side, set the vertical flap inside of the horizontal flap to the desired direction.

Setup of air direction and swinging

Refer to description of "2-way Air Discharge Cassette Type".

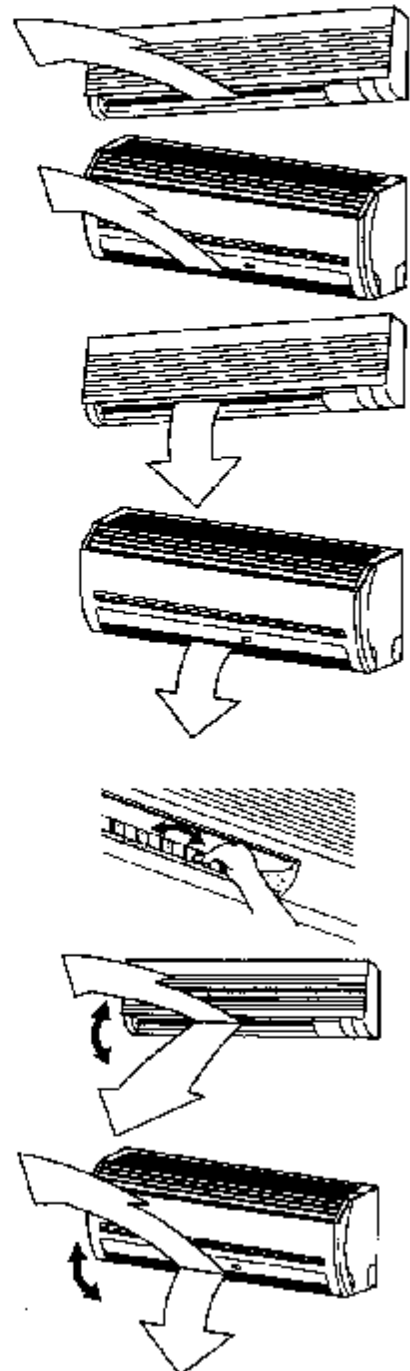

Floor Standing Cabinet Type

[In Cooling operation]

In cooling operation, use the air outlet flap with horizontal set point so that the cold air diffuses in whole room.



[In Heating operation (For Heat-pump model only)]

In heating operation, use the air outlet flap with downward set point so that the hot air blows at the foot.



How to change the air outlet port

Change the air outlet port in the following procedure.

- 1** Take off two fixing screws of the air outlet port. (The fixing screws are reused.)
- 2** Insert the hand into the air outlet port and push up it a little, and then remove the air outlet port from the claw hook at rear side.
- 3** Lift up the air outlet port upward and remove it.
- 4** Reverse the air outlet port and attach it to the main unit.
Pay attention so that four claw hooks (two at rear and lower sides each) are hooked at mounting position.
- 5** Be sure to tighten the air outlet port with the removed fixing screws so that the air outlet port does not come off.

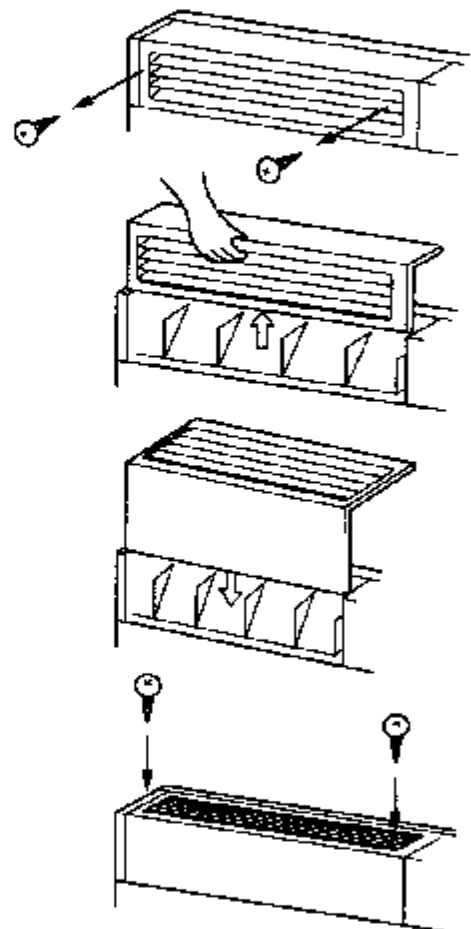

Floor Standing Type

Adjustment of air direction upward/downward

[In Cooling operation]

In cooling operation, move the flap with hands and use it with horizontal air outlet point so that the cold air diffuses in whole room.

[In Heating operation (For Heat-pump model only)]

In heating operation, move the flap with hands and use the horizontal flap with downward set point so that the hot air blows at the foot.

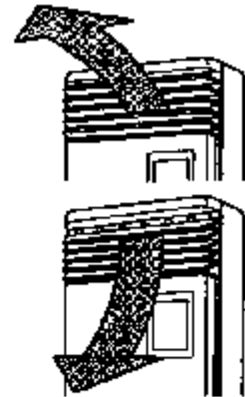

Adjustment of air direction rightward/leftward

[In case of using unsymmetrical air directions]

Lift up the vertical flap lightly, direct it toward the desired direction, and lower it.

In this case, do not use the Swing function.

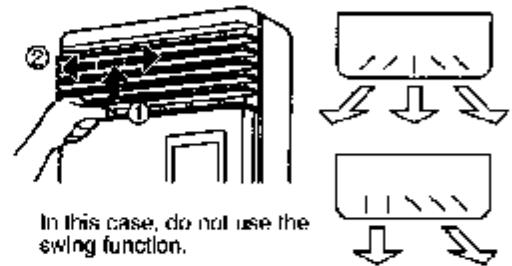

In this case, do not use the swing function.

[In case of automatic swing]

1 Push button during operation.



- [SWING ] is displayed and the air direction automatically changes rightward/leftward.

In case when one remote controller controls the multiple indoor units, each indoor unit can be selected and its air direction can be set up.

2 Push button again during swinging of the horizontal flap.

- The horizontal flap can be stopped at the desired position.

3 Swing button

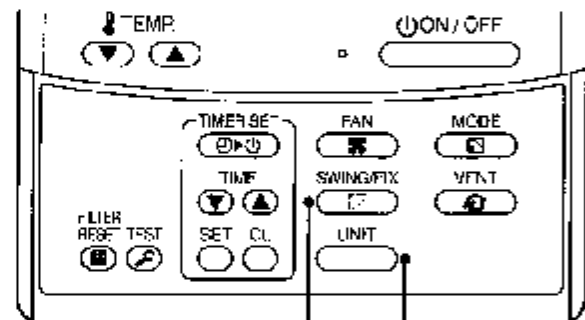

- To set up the air direction individually, push  button to display each indoor unit No. in a group control. Then set up the air direction to a displayed indoor unit.
- If there is no display, all the indoor units can be operated collectively.
- Every pushing  button, the display exchanges as shown in the figure.

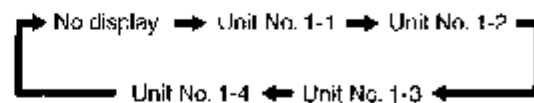

1, 2 3



INFORMATION

- If cooling operation is performed with downward air outlet, dew may fall on surface of the cabinet or the horizontal flap resulted in dripping.
- If heating operation is performed with horizontal air outlet, unevenness of temperature may increase in the room.
- Do not move the flap directly with hands during swing operation; otherwise a trouble is caused. The vertical flap does not stop immediately even if the  button is pushed. Adjusting the stop position, push the  button.

TIMER OPERATION

A type of timer operation can be selected from the following three types.

OFF timer : The operation stops when the time of timer has reached the set time.

Repeat OFF timer : Every time, the operation stops after the set time has passed.

ON timer : The operation starts when the time of timer has reached the set time.

Timer operation

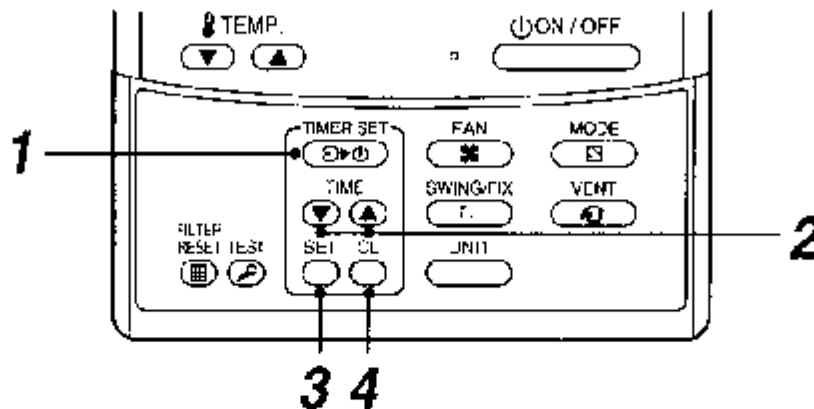

1 Push **TIMER SET** button.

- The timer display (type) changes for every push of the button.
- **SET TIME** and timer time displays flash.

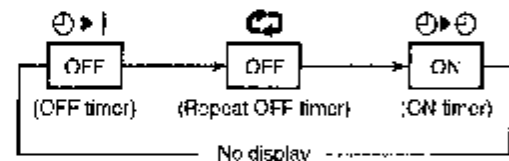

2 Push **TIME** to select "SET TIME".

For every push of **▲** button, the set time increases in the unit of 0.5 hr (30 minutes).

The maximum set time is 72.0 hr.

For every push of **▼** button, the set time decreases in the unit of 0.5 hr (30 minutes).

The minimum set time is 0.5 hr.

3 Push **SET** button.

- **SET TIME** display disappears and timer time display goes on.
(When ON timer is activated, timer time, ON timer (ON) are displayed and other displays disappear.)

Cancel of timer operation

4 Push **CL** button.

- **TIMER** display disappears.

NOTICE

- When the operation stops after the timer reached the preset time, the Repeat OFF timer resumes the operation by pushing **ON/OFF** button and stops the operation after the time of the timer has reached the set time.

INSTALLATION

Installation location

WARNING

- **Select a location for installation that will be able to safely bear the weight of the unit.**
If the installation location is not strong enough to support the unit and the unit falls, injury could result.

CAUTION

- **Do not install the unit in a location where combustible gases could conceivably leak.**
Leaking gases that accumulate in the vicinity of the unit could be ignited by the unit.

REQUIREMENT

- A location that permits level installation of the unit
- A location that provides enough space to service the unit safely
- A location where water draining from the unit will not pose a problem

Avoid the following types of locations :

- Locations where salt is present in large amounts (seaside areas), or where sulfuric gases are present in large amounts (hot springs areas)
(If the unit is to be used in such areas, special maintenance is necessary.)
- Locations that generate oils (including machine oils), steam, oily smoke, or corrosive gases
- Locations where organic solvents are used
- Locations in the vicinity of equipment that generates high frequency signals
- Locations where the outdoor unit will blow in the direction of a neighbor's window
- Locations where the noise of the outdoor unit will pose a problem
- Locations with poor air circulation

Electric wiring

WARNING

Check that earthing practice is correctly performed.

Grounding is necessary. If earthing practice is incomplete, an electric shock may be caused.

CAUTION

Check the circuit breaker is fitted.

Attaching the earth leakage breaker is necessary. Otherwise, an electric shock may be caused.

Make sure that correct capacity Fuses are used.

Using wire or copper wire may cause a fire or trouble.

For the power supply, use a circuit with rated voltage exclusive for air conditioner.

To disconnect the appliance from the main power supply.

This appliance must be connected to the main power supply by means of circuit breaker or a switch with a contact separation of at least 3mm.

MAINTENANCE

Cleaning of air filter

- When [FILTER] is displayed on the remote controller, maintain the air filter.
- Clogging of air filter decreases cooling/heating effect.

FILTER display
Notifies the time to clean the air filter.

FILTER reset
Push the FILTER switch after cleaning.
"FILTER" display disappears.

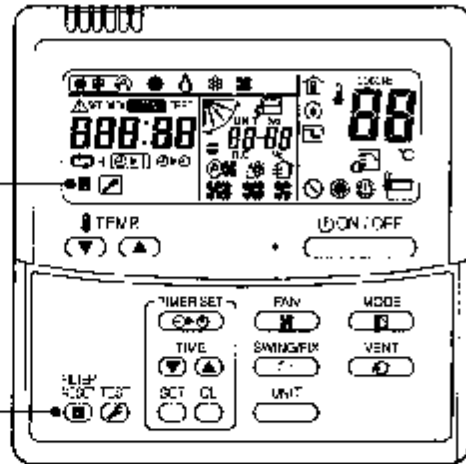

WARNING

Be sure to turn off the main power switch prior to the maintenance.

- Please do not intend to do the daily maintenance and/or Air Filter cleaning by yourself.
Cleaning of the air filter and other parts of the air filter involves dangerous work in high places, so be sure to have a service person do it. Do not attempt it yourself.

<Daily maintenance>

- For daily maintenance including Air Filter cleaning, make sure to ask the qualified service person particularly following models;

4-way Air Discharge Cassette Type
2-way Air Discharge Cassette Type
1-way Air Discharge Cassette Type

Concealed Duct Type
Slim Duct Type
Concealed Duct, High Static Pressure Type

Under Ceiling Type



2-way Air Discharge
Cassette Type



4-way Air Discharge
Cassette Type



1-way Air Discharge
Cassette Type

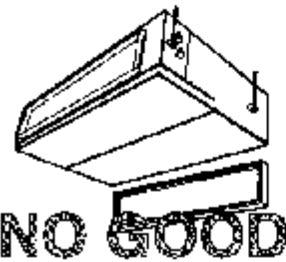

Concealed Duct Type



Under Ceiling Type

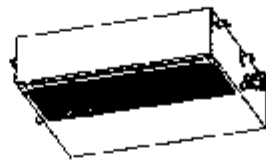

Slim Duct Type



Concealed Duct,
High Static Pressure Type

High Wall Type

(Model : 1H series)

- Push the projection at the center of air filter. Clip is out.
- Undo the clip of air filter, pull the air filter downward while pushing it toward the main unit side.

(Model : 2H series)

- Open the air inlet grille.
Lift the air inlet grille up to the horizontal position.
- Take hold of the left and right handles of the air filter and lift it up slightly, then pull downward to take it out from the filter holder.

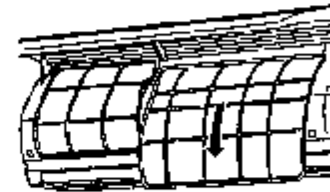
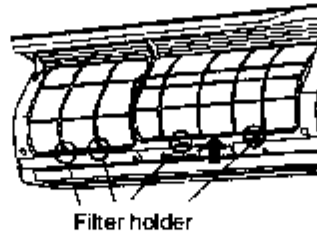
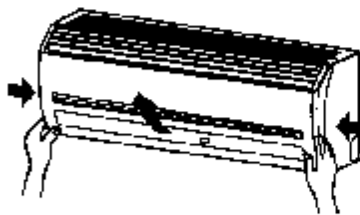
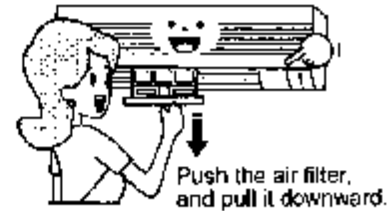

Floor Standing Cabinet Type

- Push down the upper part of the suction port a little, and then pull toward you to remove it.
- Take out the air filter inside of the suction port.



Floor Standing Concealed Type

- Push down hook of the air filter on the front panel (Lower side).
- Pull the air filter toward you to remove it.

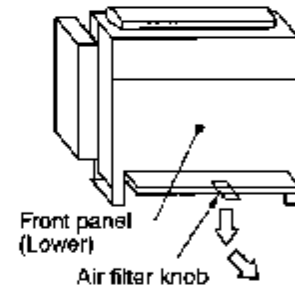

Floor Standing Type

Removal / Attachment of air filter

- Pull the air filter toward you.
- To attach the air filter, insert it into the main body and push in it.



NOTE

- For cleaning of air filter, use a cleaner or brush clean. If stain is heavy, it is effective to wash the air filter in tepid water mixed with neutral detergent.
- After washing, rinse it well, and dry it in the shade.
- Install again the air filter which has been cleaned.



Return the air filter

- Insert the upper portion of air filter confirming to fit it is right and left edges on the indoor unit until it is firmly set.
- Close the air inlet grille.

If the FILTER lamp on the indoor unit is indicated, press the FILTER button on the remote controller or the TEMPORARY button on the indoor unit to turn off the lamp.

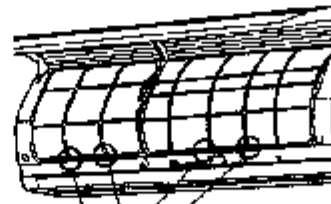
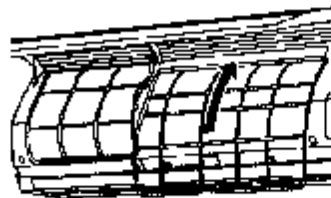

Filter holder

Cleaning the air inlet grille

1. Remove the air inlet grille.
Hold the two sides of the air inlet grille and open upwards.
Move the center arm to the left and remove the grille.
2. Wash it with water using a soft sponge or towel.
(Do not use metallic scrubbing brush or other hard brushes.)
 - Use of such hard objects will cause scratches on the surface of the grille, and the metal coating to peel off.
 - If very dirty, clean the air inlet grille with a neutral detergent for kitchen use, and rinse it off with water.
3. Wipe out water from the air inlet grille and dry it.
4. Fit the left and right arms of the air inlet grille to the shafts on the two sides of the air conditioner and push in completely, and then push in the center arm.
5. Check that the center arm has been completely inserted and close the air inlet grille.
 - Push the arrow locations (Four) at the bottom of the air inlet grille to check whether the grill is completely closed.

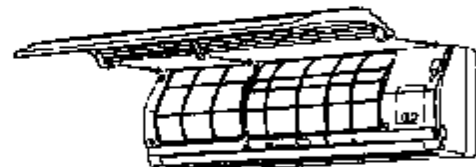
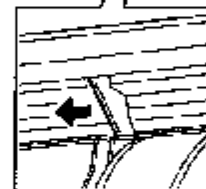

Cleaning of main unit / remote controller

CAUTION

- Wipe them with soft and dry cloth.
- A cloth dampened with cold water may be used on the indoor unit if it is very dirty.
- Never use a damp cloth on the main unit and remote controller.
- Do not use a chemically-treated duster for wiping or leave such materials on the unit for long. It may damage or fade the surface of the unit.
- Do not use benzine, thinner, polishing powder, or similar solvents for cleaning. These may cause the plastic surface to crack or deform.



Do not use.

If you do not plan to use the unit for more than 1 month

1. Operate the fan for 3 to 4 hours to dry inside the unit
 - Operate "FAN" mode.
2. Stop the air conditioner and turn off the main power switch or the circuit breaker.



Checks before operation

1. Check that the air filters are installed.
2. Check that the air outlet or inlet is not blocked.
3. Turn on the main power switch or the circuit breaker for the main power supply to the air conditioner.

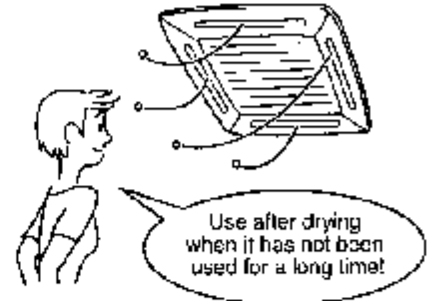

NOTE

For Air conditioning system which is operated regularly, cleaning and maintenance of the indoor/outdoor units are strongly recommended. As a general rule, if an indoor unit is operated for about 8 hours daily, the indoor/outdoor units will need to be cleaned at least once every 3-MONTH. This cleaning and maintenance shall be carried out by a qualified person. Failure to clean the indoor/outdoor units regularly will result in poor performance, icing, water leaking and even compressor failure.

HINTS FOR ECONOMICAL OPERATION

Maintain room temperature at comfortable level

Clean air filters

The clogged air filter impairs the performance of the air conditioner.

Never open doors and windows more often than necessary

To keep cool or warm air in the room, never open doors and windows more often than necessary.

Window curtains

In cooling, close the curtains to avoid direct sunlight.

In heating, close the curtains to keep the heat in.

Get uniform circulation of room air

Adjust the air flow direction for the even circulation of room air.

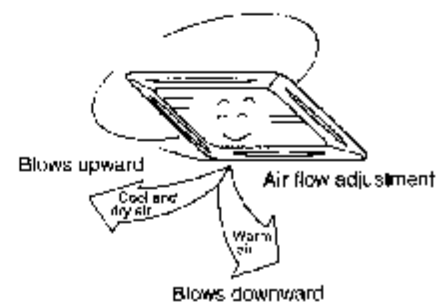
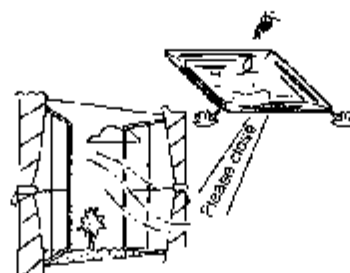

AIR CONDITIONER OPERATIONS AND PERFORMANCE

Check before operation

- Check whether earth wire is disconnected or out of place.
- Check that air filter is installed to the indoor unit.

Heating capacity (for Heat-pump model only)

- For heating, a heat pump system which sucks in outside heat air and discharges it into the room is adopted.
If temperature of the outside air lowers, the heating capacity decreases.
- When temperature of the outside air is low, it is recommended to use other heating equipment together.

Defrost operation during heating operation (for Heat-pump model only)

- If the outdoor unit has some frost during heating operation, the operation mode changes automatically to defrost mode to increase the heating effect (for approx. 2 to 10 minutes).
- During defrost operation, fans of the indoor and the outdoor units stop.

Protection for 3 minutes

- The outdoor unit does not operate for approx. 3 minutes after air conditioner has been immediately restarted after stop, or power switch has been turned on. This is to protect the system.

Main power failure

- If a power failure occurred during the operation, all operations stop.
- When the power is turned on after power failure, the operation lamp of the remote controller flashes to notify.
- When restarting the operation, push ON/OFF button again.

Fan rotation of stopped unit

- While other indoor units operate, the fan on indoor units on "stand-by" rotates to protect the machine once per approx. 1 hour for several minutes.

Protective device (High pressure switch)

The high pressure switch stops the air conditioner automatically when excessive load is applied to the air conditioner.

If the protective device works, the operation lamp keeps lit but the operation stops.

When the protective device works, check characters "△" in the remote controller display part flash.

The protective device may work in the following cases.

Cooling/heating operation of Modular Multi system air conditioner

- When suction or discharge port of the outdoor unit closed.
- When strong wind blows continuously against discharge port of the outdoor unit.
- When dust or dirt is excessively adhered to air filter of the indoor unit.
- When discharge port of the indoor unit is blocked.
- In Modular Multi system air conditioner, each indoor unit can be individually controlled.
However, cooling operation and heating operation cannot be performed concurrently for the indoor units which are connected to one outdoor unit.

When cooling operation and heating operation are performed concurrently, the indoor unit which is performing cooling operation stops, and "Ⓢ" of operation part is lit.

The indoor unit which is performing heating operation continues operation.

If the manager has fixed the setting to COOL or HEAT, other operation than set up one cannot be performed.

When other operation than set up one is performed, "Ⓢ" of operation part is lit and the operation stops.

Characteristics of heating operation (for Heat-pump model only)

- Hot air is not out immediately after the operation has started. After 3 to 5 minutes (differs according to room or outside temperature) has passed and the indoor heat exchanger has been warmed up, hot air blows out.
- During operation, the outdoor unit may stop if outside temperature becomes high.
- When other outdoor unit performs heating operation while the fan is operating, the fan operation may be stopped temporarily to prevent blowing of hot air.

WARNING

Turn on the power switch
12 hours or more before
starting before operation.