

TOSHIBA

Leading Innovation >>>

SMART MANAGER

Installation Manual

Model name: _____

BMS-SM1280HTLE

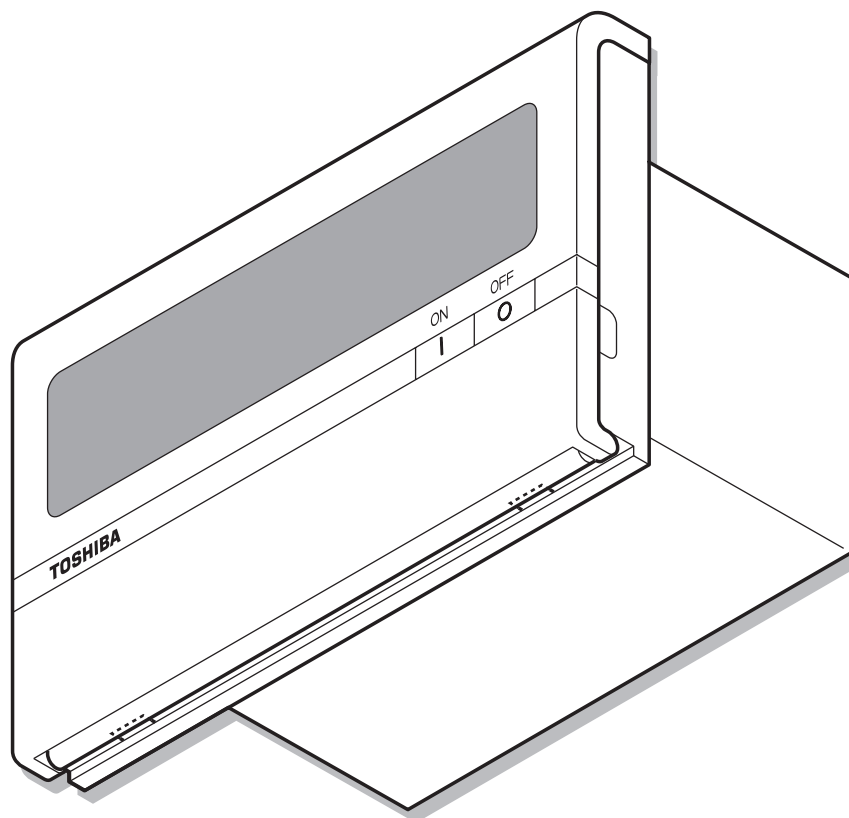

-
- Save These Instructions!
-

ENGLISH



- Thank you very much for purchasing this TOSHIBA Smart Manager.
- Please read this manual carefully beforehand for proper installation of the Smart Manager.

Contents





1 Precautions for Safety	3
2 Specifications	4
3 Installation of the Smart Manager	6
4 Connection of Power Cables/Earth Wires/Communication Cables	9
5 Switches for Setting	12
6 Central Control Address (Group Number) Setting	16
7 Mode Setting for Smart Manager	19
8 Zone Setting	20
9 Changing Return-Back Time/Temperature Settings	21
10 Test Run	22

1 Precautions for Safety



- Read these “Precautions for Safety” carefully before installation.
- The precautions described below include important items regarding safety. Observe them without fail. Understand the following details (indications and symbols) before reading the body text, and follow the instructions.
- After the installation work has been completed, perform a trial operation to check for any problems. Explain how to use and maintain the unit to the customer.
- Ask customer to keep this Manual at accessible place for future reference.

Indication	Meaning of Indication
 WARNING	Text set off in this manner indicates that failure to adhere to the directions in the warning could result in serious bodily harm (*1) or loss of life if the product is handled improperly.
 CAUTION	Text set off in this manner indicates that failure to adhere to the directions in the caution could result in serious bodily injury (*2) or damage (*3) to property if the product is handled improperly.



- *1: Serious bodily harm indicates loss of eyesight, injury, burns, electric shock, bone fracture, poisoning, and other injuries which leave aftereffect and require hospitalization or long-term treatment as an outpatient.
- *2: Bodily injury indicates injury, burns, electric shock, and other injuries which do not require hospitalization or long-term treatment as an outpatient.
- *3: Damage to property indicates damage extending to buildings, household effects, domestic livestock, and pets.

Symbols	Meaning of Symbols
	“  ” Indicates prohibited items. The actual contents of the prohibition are indicated by a picture or text placed inside or next to the graphic symbol.
	“  ” Indicates compulsory (mandatory) items. The actual contents of the obligation indicated by a picture or text placed inside or next to the graphic symbol.

WARNING

	<ul style="list-style-type: none"> • Ask an authorized dealer or qualified installation professional to install or reinstall this unit. Inappropriate installation may result in electric shock or fire. • Electrical work must be performed by a qualified electrician in accordance with this installation manual. The work must satisfy all local, national and international regulations. Inappropriate work may result in electric shock or fire. • Be sure to turn off all main power supply switches before starting any electrical work. Failure to do so may result in electric shock.
	<ul style="list-style-type: none"> • Do not modify the unit. A fire or an electric shock may occur.

CAUTION

	<ul style="list-style-type: none"> • Do not install this unit where flammable gas may leak. If gas leaks and accumulates around the unit, it may cause a fire.
	<ul style="list-style-type: none"> • Perform wiring correctly in accordance with specified the current capacity. Failure to do so may result in short-circuiting, overheating or fire. • Use predefined cable and connect them certainly. Keep the connecting terminal free from external force. It may cause an exothermic or a fire.

2 Specifications

Part name		Central Controller	Power Unit
Model name		BMS-SM1280HTLE	
Power supply		Use bundled power unit.	220 - 240 VAC, 50/60 Hz
Power consumption			7W
Connectable unit number	Indoor unit	Up to 128 units (Line1: Up to 64 units, Line2: Up to 64 units)	—
	Energy monitoring interface	Up to 4 units.	—
	Digital input/output interface	Up to 4 units	—
Operating temperature / humidity		0 °C to 40 °C, 10 to 90 %RH (no condensation)	
Dimension		120(H) x 180(W) x 64(D) mm	114(H) x 177(W) x 50(D) mm
Mass		0.8 kg	0.9 kg

■ External Dimensions

Central Controller

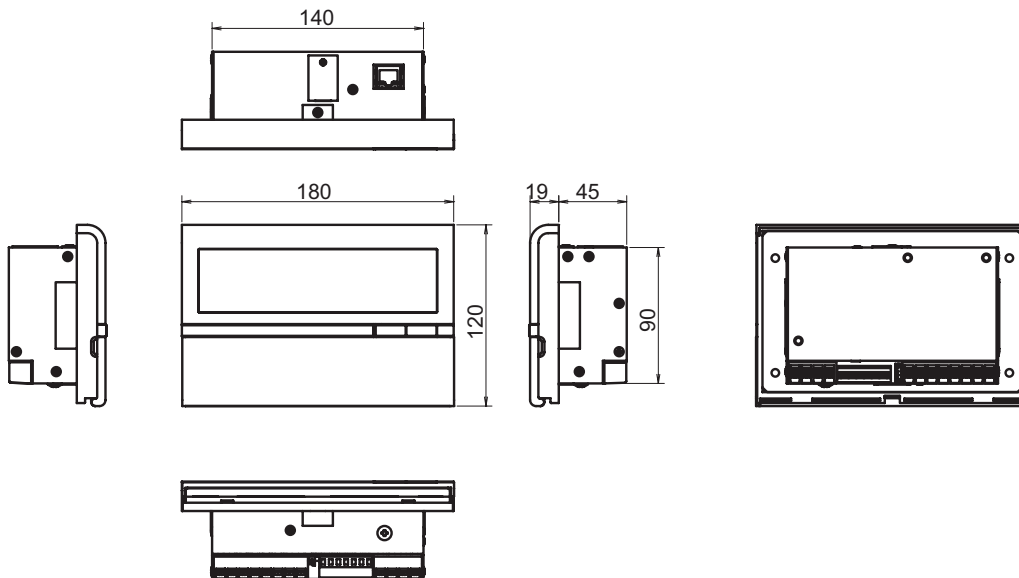

Power Unit

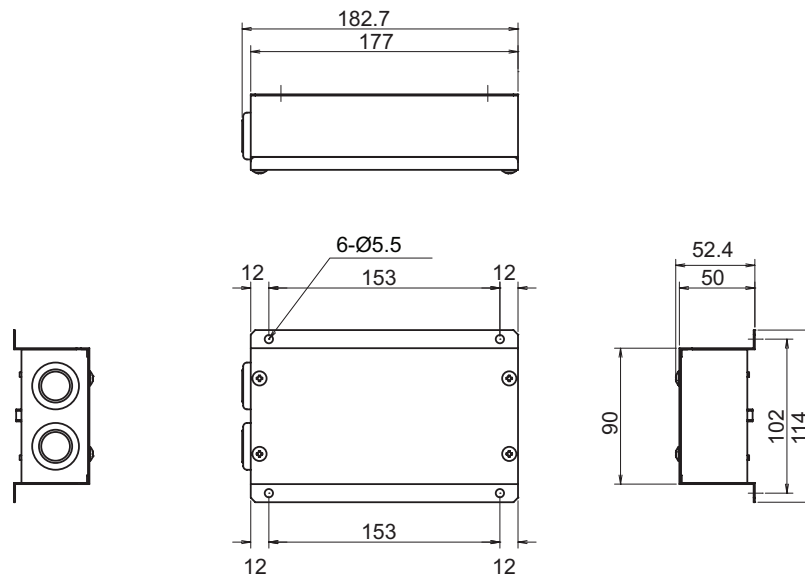

■ Before installation

Confirm all the parts on the list below are supplied.

Part name	Part name	Quantity	Remarks
1	Central Controller	1	
2	Power unit	1	
3	Installation Manual Owner's Manual Network Configuration Guide	11	11 languages English, French, German, Italian, Spanish, Portuguese, Greek, Dutch, Russian, Turkish, Chinese.
4	CD-R	1	
5	Clamp filter	1	
6	Tie-wrap	1	For fixing the clamp filter
7	Screws	8	4 for fixing the central controller 4 for fixing the power unit
8	Brackets	2	For combining the central controller and power unit.
9	Bracket screws	4	For combining the central controller and power unit

<Specifications for Wiring>

Use the following materials to connect signal lines and power lines (procured on site)

No	Line	Type/Wire size/Length
1	For TCC-LINK	2-core shield wire
		1.25mm ² , 1000m max. (total length including 2.00mm ² , 2000m max. air conditioner area)
2	For RS-485	2-core shield wire
		1.25mm ² , 500m max. (total length)
3	For power (220 - 240VAC)	H05RN-F or 245IEC57 0.75mm ² , 50m max.
4	For digital Input/Output connection	2-core wire 0.3mm ² , 100m max.
5	For power supply (Between the power unit and central controller)	4-core wire 0.75mm ² , 20m max.

3 Installation of the Smart Manager

⚠ CAUTION

- Do not twist communication wires and input/output wires with power wires or bundle them together with power wires in a metal tube. Doing so may cause malfunction.
- Install the central controller away from a noise source.

■ Installing central controller

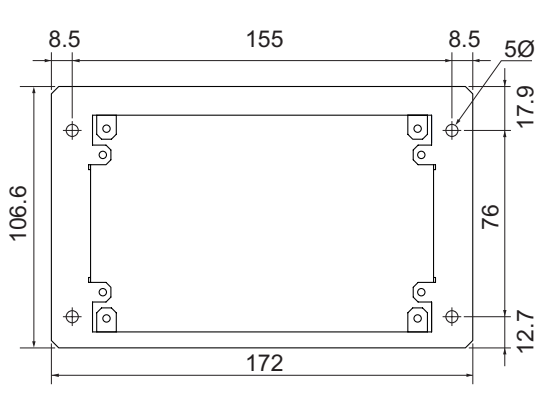
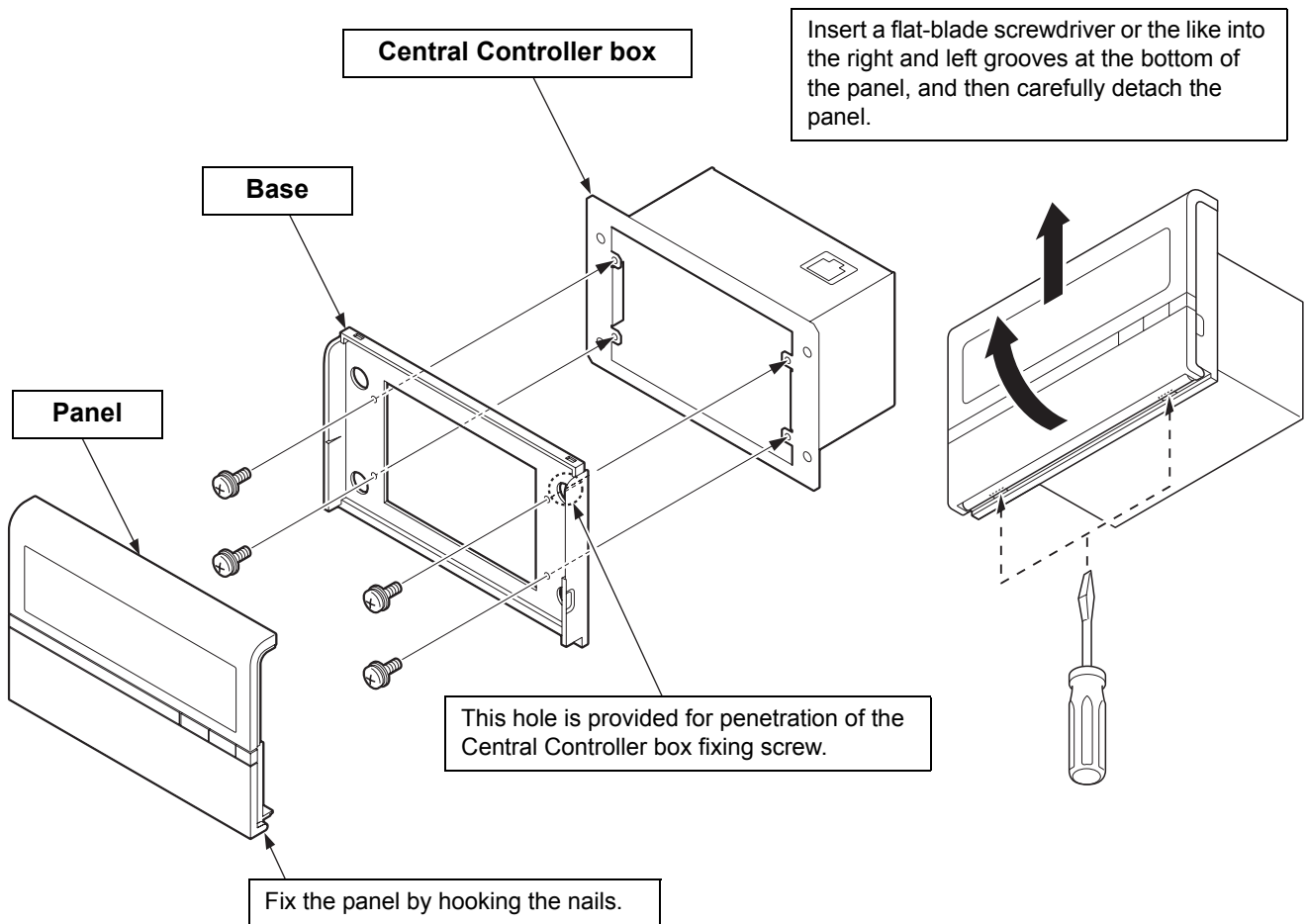

Dimensions of unit fixing holes in the wall, etc.

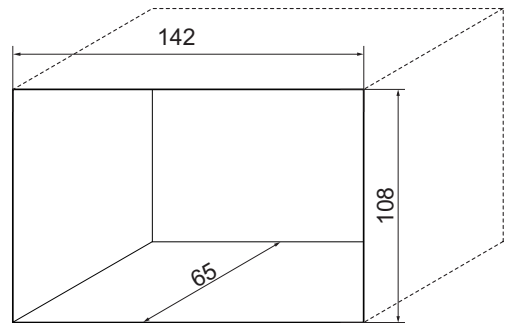

■ Power Unit Installation Method and Orientation

There are five installation methods for this power unit as shown below: surface mount and wall mounts. Use the attached screws.

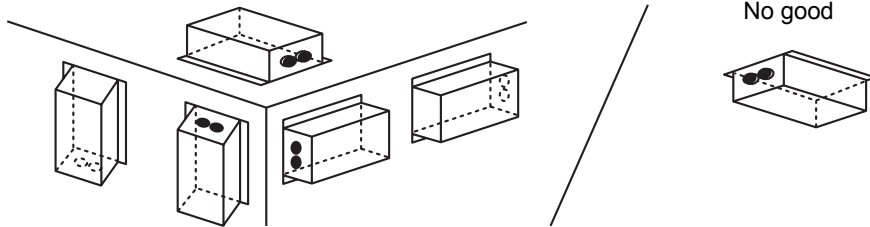

REQUIREMENT

Do not install the unit in any of the following places.

- Humid or wet place
- Dusty place
- Place exposed to direct sunlight
- Place where there is a TV set or radio within one meter
- Place exposed to rain (outdoors, under eaves, etc.)

■ Installation Space and Maintenance Space

A side space for connecting through cable inlets and an upper space for maintenance must be reserved before installation.

The other sides can be adjacent to surrounding objects.

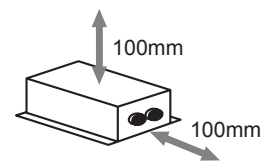

■ Combining the Central Controller and Power Unit

You can combine the central controller and power unit using the supplied brackets as follows in order to control them as one unit

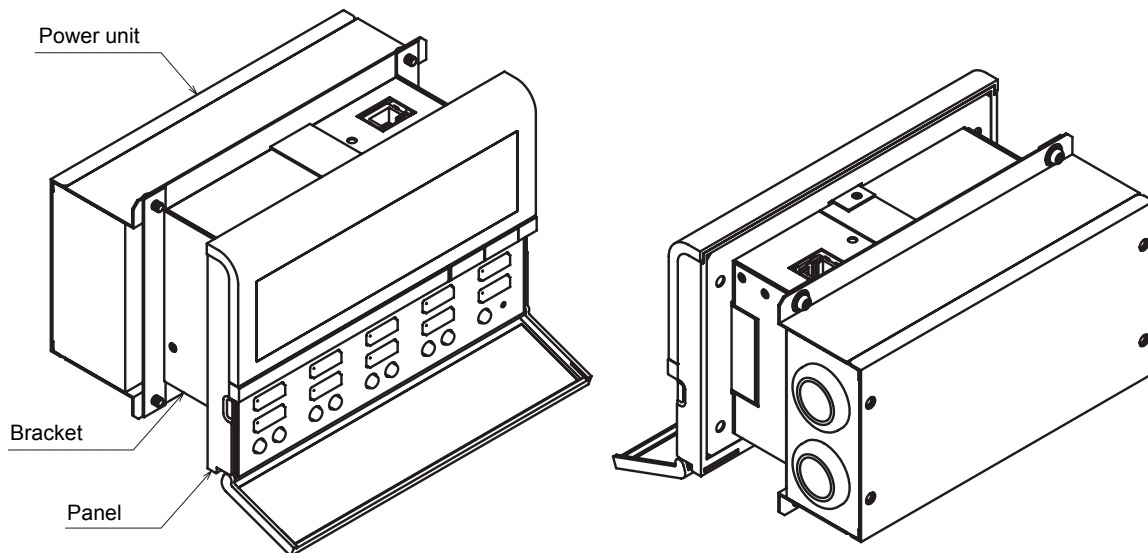

Combination method

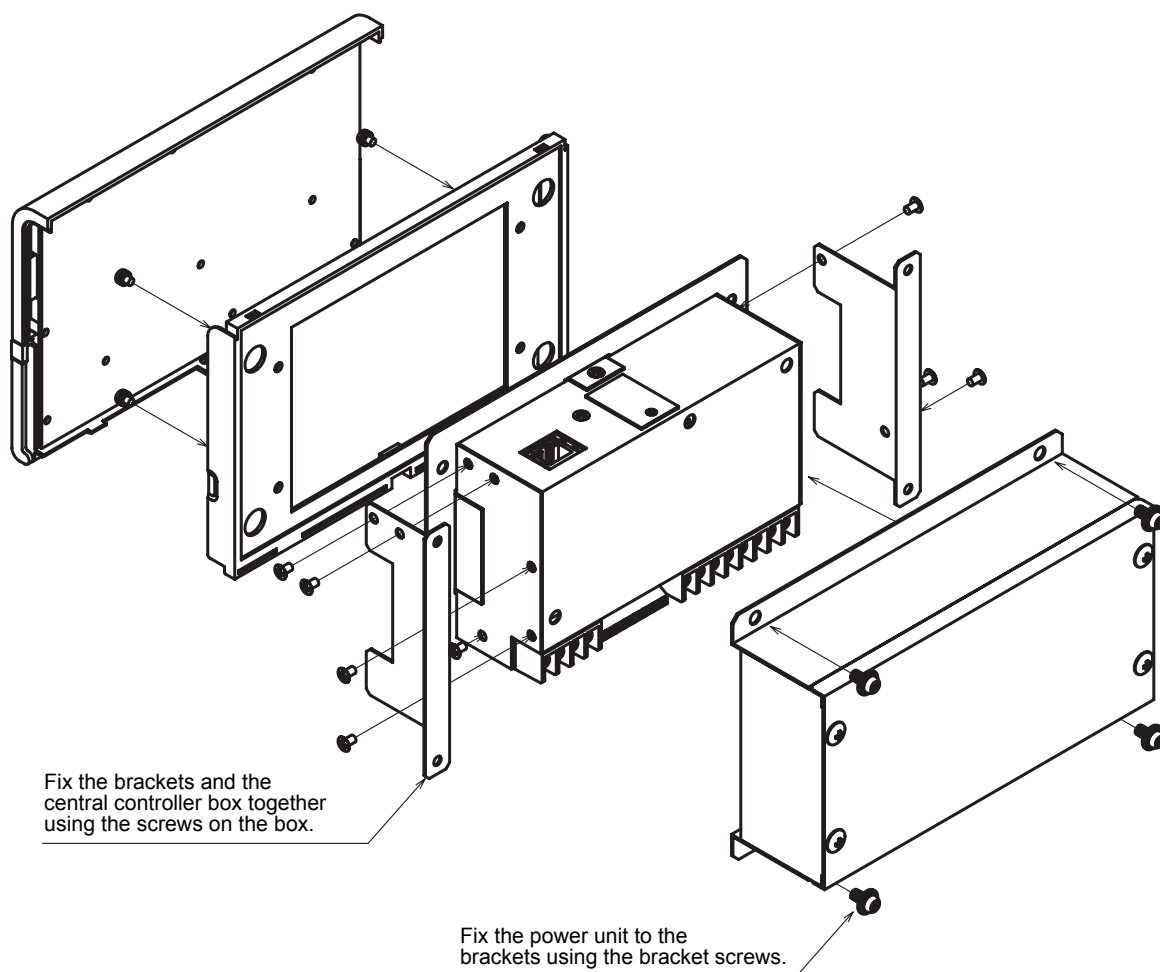

4 Connection of Power Cables/Earth Wires/ Communication Cables

Connect power cables, communication cables, and earth wires to the specified terminals on the terminal block.

REQUIREMENT

Attach a round pressure terminal to the end of each wire except those for digital input and output.

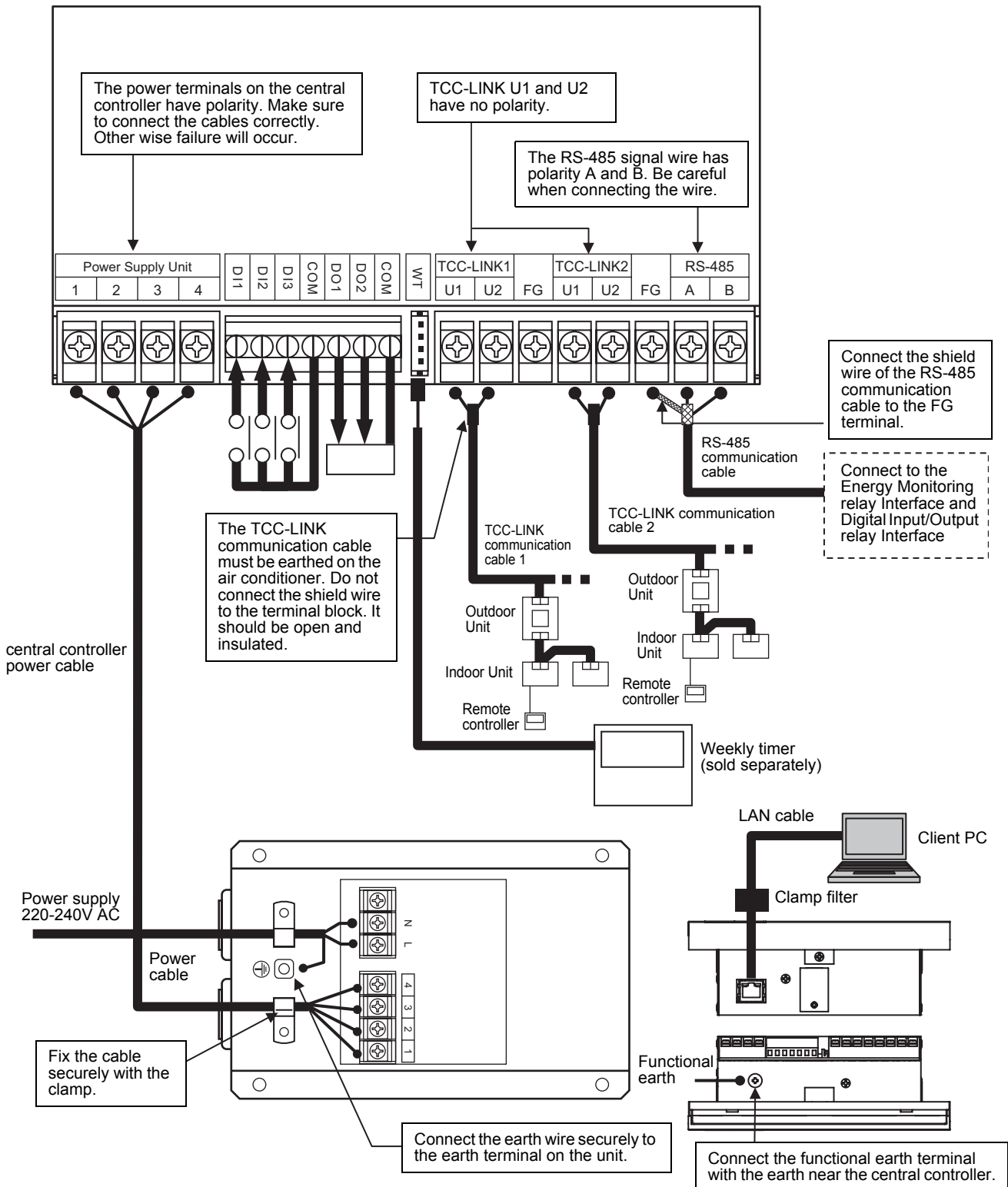

Length of stripped power cable

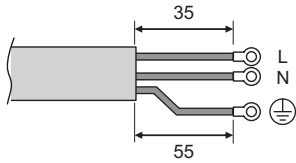

Attach a round pressure terminal to the end of each wire of the power cable, communication cable and power cable for central controller.

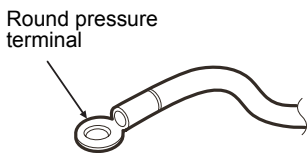

Length of stripped TCC-LINK communication cable

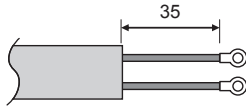

Attach the supplied clamp filter to the LAN cable.
 * Wind the LAN cable around the clamp filter as shown below when attaching the filter to the cable. After attaching the filter, fix it to the LAN cable using a supplied tie-wrap.
 * Attach the clamp filter as near the main unit as possible.

LAN cable

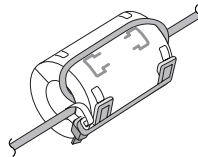

Length of stripped RS-485 communication cable

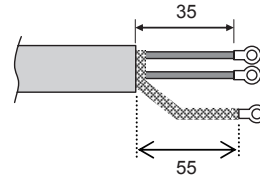

Length of stripped digital Input/Output communication wire

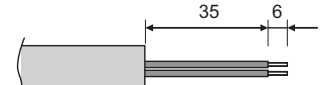

Loosen the screw with the screw driver, insert the digital input/output communication wire, then tighten the screw again to fix the wire firmly.

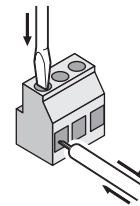

REQUIREMENT

- Disconnect the appliance from the main power supply. This appliance must be connected to the main power supply by a circuit breaker or switch with a contact separation of at least 3mm.
- Fasten the screws to the terminal with torque of 0.5Nm.

■ Connections to External Equipment

Example of connection to external equipment which is connected to digital input/output connector.

Designation	Input/Output item	Central Controller side		External equipment side	
		Input/output conditions	Terminal name	Example of circuit	Input/output conditions
DO1 (Alarm output) DO2 (Run output) DO-COM (Output common)	Status output	Allowable terminal voltage/current DC24V/35mA	DO1 DO2 DO-COM		Wiring length: 100 m or less
DI1 (All stop input) DI2 (All start input) DI3 (Fire alarm input) DI-COM (Input common)	Control input	Non-voltage A contacts Pulse or static * Non voltage contacts must be compatible with minimal current. DC5V/3mA	DI1 DI2 DI3 DI-COM		Pulse width: 300 ms or more Wiring length: 100 m or less

A connection example of system wiring is shown below.

Connection of wiring

Here is shown a connection example of smart manager wiring to indoor units, Energy monitoring relay interface, Digital Input/Output relay interface and client PC.

Termination setting

- RS-485 termination: Terminate both ends of RS-485 wire; one end on the smart manager and the other on the interface. The termination on the smart manager has been set at shipping. For the termination on the interface, refer to the Installation Manual of the interface.
- TCC-LINK termination: Terminate it in indoor units. Do not terminate on the smart manager; leave it open.

Earthing the shield wire

- RS-485 cable’s shield wire: Connect it to the FG terminal.
- TCC-LINK cable’s shield wire: Do not connect it to the FG terminal. TCC-LINK cable must be earthed on the air conditioner.

Group/zone/line settings of indoor units

- The settings of indoor units can be configured collectively by groups, zones or lines.
- Groups 1-64 correspond to the central control addresses 1-64 for indoor units, respectively. See “6.Central Control Address (Group Number) Setting”.
- A smart manager has two TCC-LINK communication lines: line 1 and line 2. Each line can contain up to 64 groups and 64 zones, and 128 groups and 128 zones can be set in total.
- A zone is a control unit consisting of a combination of any indoor units. You can make up to 64 zones pairing any of up to 64 groups. For setting zones, see “8.Zone Setting”.

Connecting interface

Connect the Energy monitoring relay interface and Digital Input/Output relay interface to the RS-485 communication cable. See the Installation Manuals of the interface for details.

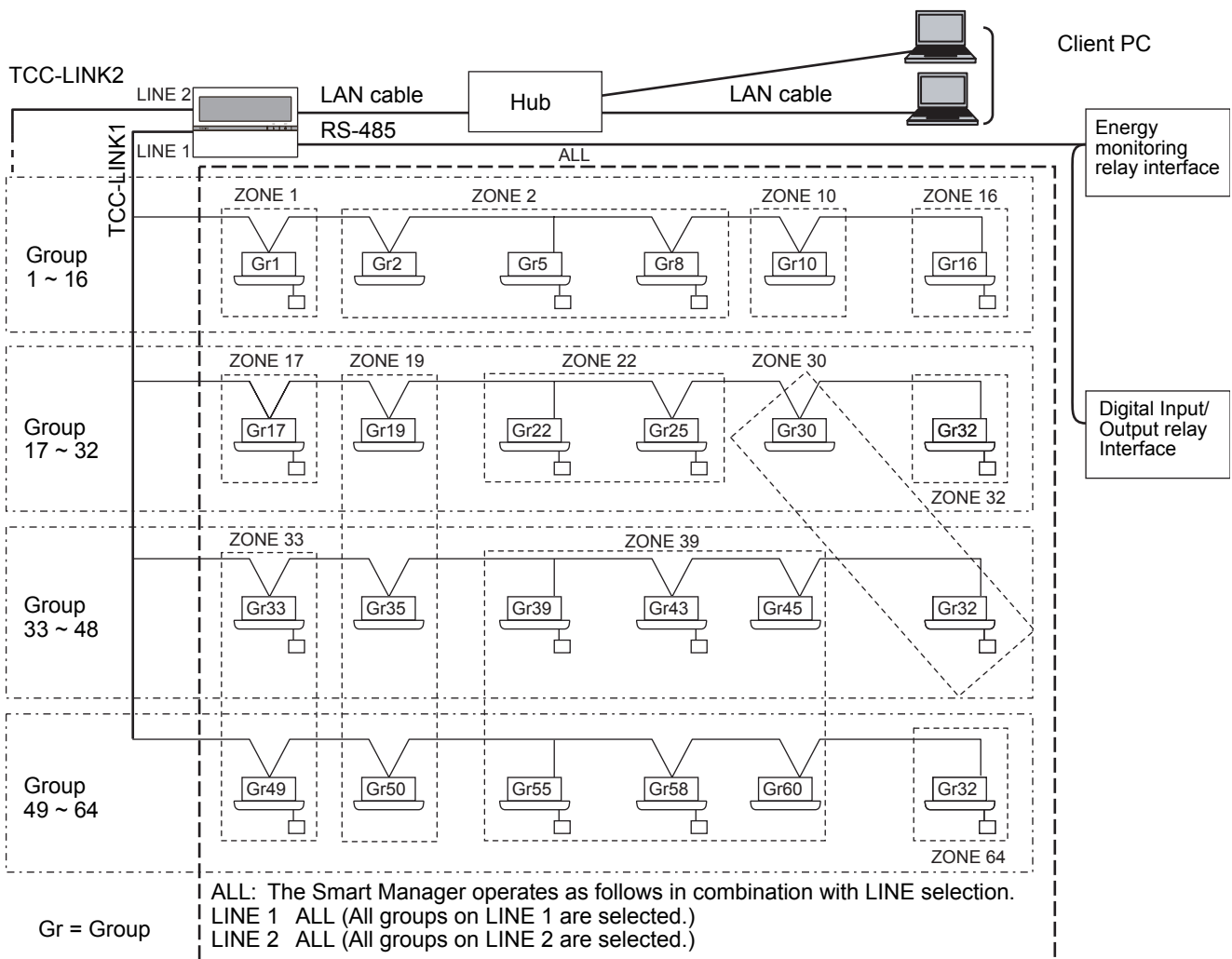

5 Switches for Setting

The switches for settings are equipped on the back of the panel.

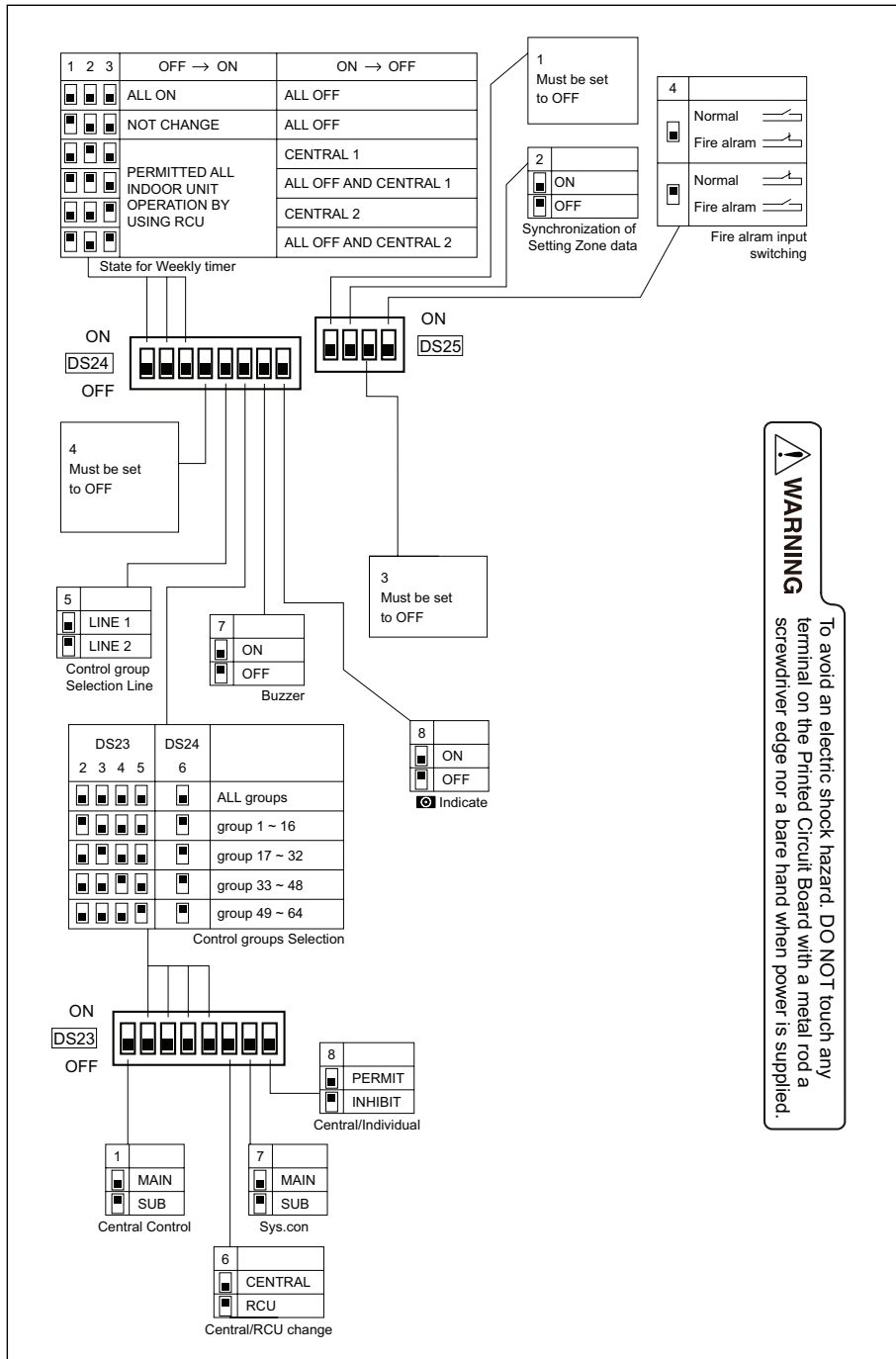

<DS23>

Factory setting: All OFF

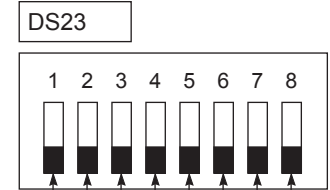

<1> Smart Manager main/sub selection
 OFF: Main
 ON: Sub

Normally, this bit is set to OFF.

When two Smart Manager units are used as a main unit and a sub unit with the same mode setting, set this bit to OFF (Main) for one unit and to ON (Sub) for the other unit.

<2> to <5> Control group selection

Control group selection	DS24-<6>	DS23
All groups	OFF	-
Group 1 ~ 16	ON	<2> ON
Group 17 ~ 32	ON	<3> ON
Group 33 ~ 48	ON	<4> ON
Group 49 ~ 64	ON	<5> ON

These bits specify a group range used in the control group selection. The Smart Manager for which control group selection is set controls only groups within the set group range.

To use the control group selection, set DS23-<2> to <5> and DS24-<5> to <6>. For details, see "7.Mode Setting for Smart Manager".



<6> Central control/remote controller mode selection
 OFF: Central control mode
 ON: Remote controller mode

Central control mode: The smart manager is used as the central control device.
 Remote controller mode: The smart manager is used as the remote controller.

<7> Central control Main/Sub selection
 OFF: Main
 ON: Sub

This setting is required when multiple Smart Manager units are used or another central control unit is used.

(1) Set this bit to OFF when one Smart Manager unit is used.
 (2) When multiple central control units are used as a main unit and sub units, set to OFF (Main) for one unit and set to ON (Sub) for other units.

<8> Central button enable/disable
 OFF:  button operation is permitted
 ON:  button operation is inhibited

* The  button is disabled in the remote controller mode regardless of this setting.

<DS24>

Factory setting: All OFF

DS24

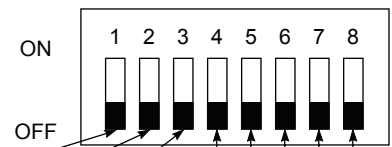

<1> to <3> Timer input switching

These bits switch operation when the weekly timer has changed.

- Use (1) and (2) only in the remote control mode.
- When the control group selection is used, “All ON,” “All OFF” and “all indoor units” mean those within the set group range.

Central controller operation		Switch No.			
		<1>	<2>	<3>	
	Timer OFF → ON	Timer ON → OFF			
(1)	All ON	All OFF	OFF	OFF	OFF
(2)	No change	All OFF	ON	OFF	OFF
(3)	All indoor units are locally controllable.	All indoor units CENTRAL 1	OFF	ON	OFF
(4)		All OFF and all indoor units to be CENTRAL 1	ON	ON	OFF
(5)		All indoor units CENTRAL 2	OFF	OFF	ON
(6)		All OFF and all indoor units to be CENTRAL 2	ON	OFF	ON

CENTRAL 1: Disables operation start/stop using the remote controller.

CENTRAL 2: Disables operation start/stop, operation mode switching, and temperature setting using the remote controller.

<4> Always OFF

Always set this bit to OFF.

<5> Control group Selection line

OFF: LINE 1

ON: LINE 2

* Set a line number for which the control group selection is used.

<6> Control group selection enable

OFF: Normal mode

ON: Control group selection

Set this bit to ON when the control group selection is used.

* To use the control group selection, set DS23-<2> to <5> and DS24-<5> to <6>. For details, see “7.Mode Setting for Smart Manager”.

<7> Buzzer

OFF: With buzzer sound

ON: Without buzzer sound

<8>  indication

OFF: Displayed

ON: Not displayed

<DS25>

Factory setting: All OFF

<1> Always OFF
 • Always set this bit to OFF.

<2> Synchronization of zone setting data
 OFF: With synchronization
 ON: Without synchronization
 This bit specifies whether to perform synchronous communication of zone setting data between Smart Managers.
 * When this bit is set to ON (without synchronization), synchronous communication is not performed, and when zone setting is made, the data is not reflected in other Smart Managers.

<3> Always OFF
 • Always set this bit to OFF.

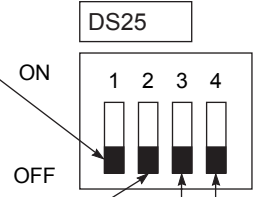

<4> Fire alarm input switching (Set this switch to match the fire alarm input connection set in chapter 4.)
Set OPEN or CLOSE input junction pegged to fire alarm.

- OFF: Set CLOSE input junction pegged to fire alarm.

(Normal)

(Fire alarm)

- ON: Set OPEN input junction pegged to fire alarm.

(Normal)

(Fire alarm)

Termination

The termination switches for TCC-LINK are placed in the central controller box. Detach the panel when configuring termination setting.

NOTE

TCC-LINK connection is terminated on indoor units. Set SW 200 to "Open" for both TCC-LINK 1 and 2.

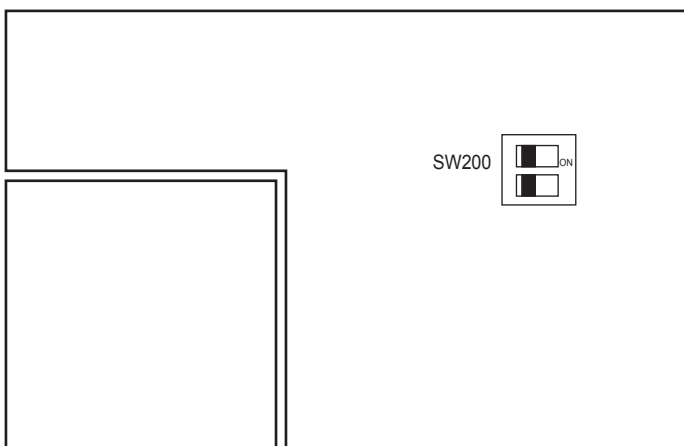

SW200	TCC-LINK termination switches			
	TCC-LINK1	Open	TCC-LINK1	100Ω
	TCC-LINK2	Open	TCC-LINK2	Open
	TCC-LINK1	Open	TCC-LINK1	100Ω
	TCC-LINK2	100Ω	TCC-LINK2	100Ω

6 Central Control Address (Group Number) Setting

- Central control addresses must be assigned to all air conditioners to be controlled.
- Under the control of the Smart Manager, central control address equals group number.

<Preparations for central control address (group number) setting>

- Turn on the power of all indoor and outdoor units.
- This Smart Manager or a standard wired remote controller is necessary for setting central control addresses.
- Terminate the operation of air conditioners, and then set central control addresses.
- * To set central control addresses with the Smart Manager, initial communication with all connected indoor and outdoor units must have been completed. Therefore, wait at least 10 minutes after power-on, and then start central control address setting.

NOTE

If the address setting is made before the initial communication is completed, an address is not assigned to some units.

- Connect terminals U1 and U2 in the outdoor unit (Header unit) to the relay connector of terminals U3 and U4.
- Set SW30-2 on the interface P.C. board of the outdoor unit (Header unit) to ON only for one system, and to OFF for others.
- * The location of SW30 is shown in the wiring diagram supplied with the outdoor unit.







<Setting central control addresses (group numbers)>

Use “manual setting from wired remote controller,” “manual setting,” or “automatic setting” to set central control addresses.

A Manual setting from wired remote controller













Set central control addresses (group numbers) from a standard wired remote controller.

* The following setting procedure is described based on button operations of the wired remote controller RBC-AMT32E.

- (1) Press the  button and  button simultaneously for at least 4 seconds.
(Note: Do not press the  button during setting.)
- (2) Press the  button to change the CODE No. 03.
- (3) Set central control addresses (group numbers) with the  buttons.
 - Group numbers used for the Smart Manager are central control addresses (DN item 03).
 - The effective address range is 1 to 64. However, there must be no duplicate address on the same line.
 - An address value of 99 indicates that the address is not set.
- (4) Press the  button to fix the setting.
- (5) Press the  button to exit the address setting mode.
 - * This setting procedure may vary depending on the wired remote controller model.
 - * Perform these steps while air conditioners are not working.

B Manual setting







Set central control addresses (group numbers) manually from the Smart Manager.

- (1) Press the  button and ZONE  button simultaneously for at least 4 seconds. (CODE No. C1 flashes.)
- (2) Check CODE No. C1, and then press the  button.
- (3) Select the line on which the unit exists and the zone and group in which addresses are to be registered with the LINE button, ZONE  and  buttons, and GROUP  and  buttons.
 - When a zone is selected, group numbers registered in the zone are displayed.
 - Groups whose numbers are displayed are already registered.
 - Even when addresses have been registered, the registration can be cancelled with the  button.
- (4) Select the unit to be registered in the group selected in step (3).
 - Switch refrigeration system No.1 to 31 with the  button, and then switch indoor unit No.1 to 64 with the  button.
 - When no system exists, indoor unit number is displayed as “- -”.
 - System number 31 is for a local adapter and heat exchange ventilators. An indoor unit number is always displayed regardless of whether the unit exists or not.
- (5) Press the  button to register the setting or press the  button to cancel the setting.
- (6) To continue registration, repeat steps (3) to (5).
- (7) Press the  button to terminate the address setting.

C Automatic setting

Set central control addresses automatically from the Smart Manager.

(Central control addresses are set automatically in ascending order of unit number.)





- (1) Press the  button and ZONE  button simultaneously for at least 4 seconds. (CODE No. C1 flashes.)
- (2) Press the SET TEMP.  or  button to change the CODE No. to C2.
- (3) Press the  button. (Central control addresses are automatically registered. This registration requires several minutes. **SETTING** lights during this address setting.)
- (4) **SETTING** goes out and the indication of C2 flashes, which shows completion of the automatic address registration.
- (5) Press the  button to exit the address setting mode.

<Checking duplicate central control address>

NOTE







This function is not available for light commercial air conditioners.

For details, refer to the manual of the TCC-LINK adapter.

- (1) Press the  button and ZONE  button simultaneously for at least 4 seconds. (CODE No. C1 flashes.)
- (2) Press the SET TEMP.  or  button to change the CODE No. C3.
- (3) Press the  button to start checking a duplicate central control address error. (**SETTING** lights during this check.)
- (4) When **SETTING** goes out, the check has been completed.
 - * When nothing appears in the group number display area at the end of checking, no duplicate address error has been detected.
 - * When a group number in the group number display area flashes at the end of checking, a duplicate address error has been detected. (Correct the duplicate address.)

<Correcting duplicate address>

Correct the duplicate address detected through the check using the following procedure.

- (1) When the duplicate address check has been completed, select CODE No. C1 with the SET TEMP.  or  button.
- (2) Press the  button.
- (3) The number of group in which the error has been detected flashes.
Select the flashing group number to be corrected with the GROUP  or  button.
- (4) Press the  button to clear the set incorrect central control address.
After that, set a correct central control address.
- (5) Press the  button to terminate the duplicate address correction.

7 Mode Setting for Smart Manager

■ Operation mode

You can switch the functional mode of the smart manager between the central control mode and remote control mode. The mode is switched with the dip switch DS23-<6>.

OFF side: Central control mode

This Smart Manager is used as a central control unit.

Settings with the remote controller are inhibited by the setting of the Smart Manager.

ON side: Remote control mode

This Smart Manager is used as a remote controller.

Settings with the Smart Manager are inhibited by the setting of another central control unit.

■ Control group selection

An arbitrary range of a line and 16 groups (1 to 16, 17 to 32, 33 to 48, and 49 to 64) can be selectively set.

		DS23				DS24	
		<2>	<3>	<4>	<5>	<5>	<6>
All groups		OFF	OFF	OFF	OFF	OFF	OFF
LINE 1	Group 1 to 16	ON	OFF	OFF	OFF	OFF	ON
	Group 17 to 32	OFF	ON	OFF	OFF	OFF	ON
	Group 33 to 48	OFF	OFF	ON	OFF	OFF	ON
	Group 49 to 64	OFF	OFF	OFF	ON	OFF	ON
LINE 2	Group 1 to 16	ON	OFF	OFF	OFF	ON	ON
	Group 17 to 32	OFF	ON	OFF	OFF	ON	ON
	Group 33 to 48	OFF	OFF	ON	OFF	ON	ON
	Group 49 to 64	OFF	OFF	OFF	ON	ON	ON
Example: When setting LINE 1 (group 1 to 32) in the control group selection		ON	ON	OFF	OFF	OFF	ON

* When the control group selection is not used ("ALL group"), all groups and zones on LINE 1 and LINE 2 can be controlled.

* When the control group selection is used, only groups and zones in the set group range can be controlled.

- When the control group selection is used, groups and zones outside this range are not displayed and cannot be operated.

- **ALL** means the entire set group range.

- Zones can be registered and operated only within the set group range. (No groups outside the range can be registered or operated.)

- The group control mode is available only for one line.

* Multiple group ranges can be specified by the control group setting.

(Example) When groups 33 to 48 and groups 49 to 64 are specified at the same time, a group range (groups 33 to 64) is set by the control group setting.

8 Zone Setting



■ What is zone?

- A zone is a control unit consisting of a combination of any indoor units and the settings of indoor units in a zone can be configured collectively.
- You can make up to 64 zones pairing any of up to 64 groups in a line. By using lines 1 and 2, you can set up to 128 zones in total.
- As factory setting, each zone contains one group to make zone numbers equal to group numbers.



■ Setting zones

Register groups in a zone or cancel them.

(1) Change the mode to the zone setting mode.







- Press the  button,  button, and ZONE  button simultaneously for at least 4 seconds. (The displayed zone number flashes and the Smart Manager enters the zone setting mode. Indicates CODE No. "E1".)

(2) Select the zone to be set.



- Select the zone number to be set with the ZONE  or  button, and then press the  button to fix the selection. (When the selection has been fixed, the selected zone number lights.)
- When selection of zone has been fixed, the [] marks of the group numbers registered in the zone light up.

(3) Change registration of groups in a zone.

Register groups in a zone.

1. Select the group number to be set with the GROUP  or  button. Pressing the SET TEMP.  or  button skips the group number by +16 or by -16.
2. Press the  button. The registered group number stops flashing and lights still.
3. Pressing the  button restores the state before the  button is pressed.
4. To continue registration of groups, repeat this procedure from the 1..

NOTE

No zone data has been stored at this time. If the ZONE  or  button is pressed before the registration change is fixed, the set content for registration change is discarded.

(4) Fix the registration change.

Press the  button. The set content for registration change is stored in the memory.

- * After the memory write operation has been completed, the Smart Manager exits the zone setting mode.

NOTE

- Any indoor unit cannot be registered on to two or more zones at the same time. If you register a group of a zone on to another zone, the group is eliminated from the old zone.
- Zone registration of a group cannot be cancelled. To exclude a registered group from a zone, register it on another zone.

9 Changing Return-Back Time/Temperature Settings

■ What is return-back?

When the return-back function is activated, the temperature setting exceeding the return-back temperature will automatically be adjusted to the return-back temperature after a certain period of time to prevent extremely high/low temperature setting.

■ Setting the return-back time and temperature

Follow the procedure below to set the return-back time and temperature.

NOTE









Do not change the data of CODE No. 0A and the following item codes to prevent the remote controller from malfunctioning.

Two sets of return-back settings, Return-back 1 and 2, can be stored. Select Return-back 1 or 2 using  buttons when activating the return-back function.

CODE No.	Item	Data	
		Factory setting	Setting range
01	Activate/deactivate the return-back function	001 (Enabled)	000 (Disabled), 001 (Enabled)
02	Time setting of Return-back 1, for heating	030 (30 minutes)	1 to 60 minutes (in units of 1 minute)
03	Time setting of Return-back 1, for cooling	030 (30 minutes)	1 to 60 minutes (in units of 1 minute)
04	Temperature setting of Return-back 1, for heating	018 (18°C)	18 to 29°C (in units of 1°C)
05	Temperature setting of Return-back 1, for cooling	028 (28°C)	18 to 29°C (in units of 1°C)
06	Time setting of Return-back 2, for heating	030 (30 minutes)	1 to 60 minutes (in units of 1 minute)
07	Time setting of Return-back 2, for cooling	030 (30 minutes)	1 to 60 minutes (in units of 1 minute)
08	Temperature setting of Return-back 2, for heating	018 (18°C)	18 to 29°C (in units of 1°C)
09	Temperature setting of Return-back 2, for cooling	028 (28°C)	18 to 29°C (in units of 1°C)

Changing settings

The following shows an example of changing the time (factory setting) in the case of return-back 1 heating from 30 minutes to 45 minutes.

- (1) Change the mode to the CODE No. setting change mode.
Press the , , and ZONE  buttons simultaneously for at least 4 seconds.
(**SETTING** and CODE No. flash.)
- (2) Change the CODE No.
Press SET TEMP.   buttons to set the CODE No. to "02".
(CODE No. "02" and time setting "30" flash.)
- (3) Change the time setting.
Press GROUP   buttons to set the time setting to "045".
- (4) Press the  button to determine the data. **SETTING** and CODE No. stop flashing and stay lit.
To continuously change other settings, repeat steps (2) to (4) above.
- (5) Determine the change.
Press the  button to write the updated data in the memory of the remote controller.
* When the data has completely been written in the memory, the CODE No. setting change mode is exited.

NOTE





Setting adjustment is cancelled without determining the change.

10 Test Run

<Conducting a Test Run for the Smart Manager>

- A test run is necessary to confirm that the Smart Manager has recognized air conditioner units after the central control address setting.
 - (1) Turn on the power of all connected air conditioners.
 - (2) Turn on the power of the Smart Manager.
 - (3) Make sure that the number of air conditioners connected to each line (only main units when group control is performed) equals the group number count displayed on the Smart Manager.
 - (4) When these numbers are identical, there is no problem.
If they differ, set central control addresses again according to “Central Control Address (Group Number) Setting.” Also make sure that there is no incorrect wiring.

<Conducting a Test Run for Air Conditioners>

- (1) Press the  button for at least 4 seconds. (The “TEST” indication lights in the test run mode.)
- (2) Confirm that pressing the  /  buttons starts/stops air conditioning. (Temperature setting is not adjustable during test run.)
- (3) When the test run is completed, press the  button to exit the test run mode.

TOSHIBA CARRIER CORPORATION
336 TADEHARA, FUJI-SHI, SHIZUOKA-KEN 416-8521 JAPAN

DE93919101